

ACCESSORI PER SCORREVOLI ACCESSORIES FOR SLIDING DOORS / ZUBEHÖR FÜR SCHIEBETÜREN

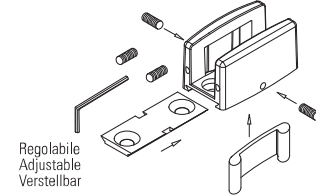

V-012-INS

- Guida a pavimento regolabile per vetro da 8 a 13,5 mm con piastrina di fissaggio a terra per un facile inserimento della guida ideale per scorrevoli invisibili e Telescopici
- Floor guide adjustable for glass from 8 to 13,5 mm. Perfect for Invisible and Telescopic
- Bodenführung verstellbar für Glas von 8 bis 13,5mm perfekt für invisible und Teleskop Schiebe-Systeme, dank der Befestigungsplatte einsetzbar

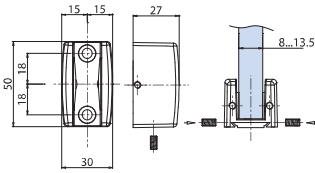
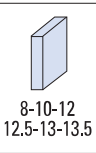

€▶ A.630

FB059-A



V-012-REG

- Guida a pavimento regolabile per vetro da 8 a 13,5 mm
- Floor guide adjustable for glass from 8 to 13,5 mm
- Bodenführung verstellbar für Glas von 8 bis 13,5mm

AN - NS - CR

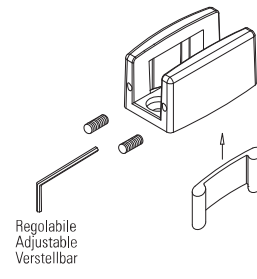
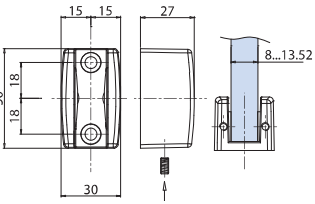
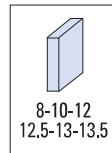

€▶ A.629

FB059-A



V-012-EVO

- Guida a pavimento regolabile per vetro 8-10-12 mm
- Floor guide adjustable for glass 8-10-12 mm
- Bodenführung verstellbar für Glas 8-10-12 mm

AN - NS - CR - NO

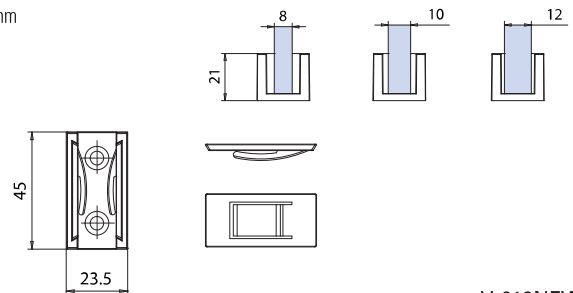
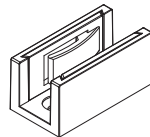
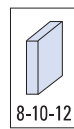

€▶ A.628

V-012NEW



P-F08

- Guida a pavimento per pannello in legno
- Floor guide for sliding wooden panel
- Bodenführung für Schiebetüren aus Holz

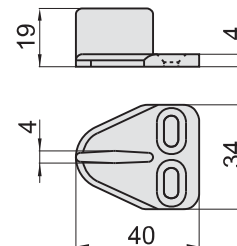

€▶ A.638

P-F08



V-012

- Guida a pavimento per vetro 8/10 mm
- Floor guide with felt strips for glass sliding door a 8 and 10mm
- Bodenführung für Glas 8/10 mm

AN - NS - CR

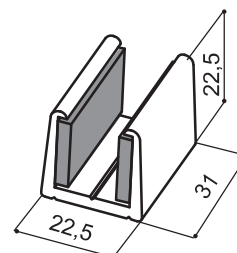
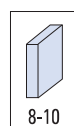

€▶ A.627

V-012

V-014

- Guida a pavimento per scorrevole regolabile 8/10 mm
- Floor guide adjustable 8/10 mm
- Bodenführung verstellbar für 8, 10 mm Glasdicke
CS - NS - CR - OL - CP

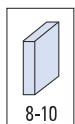

8-10

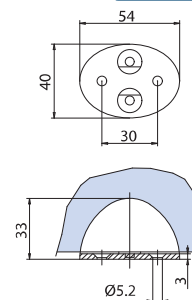
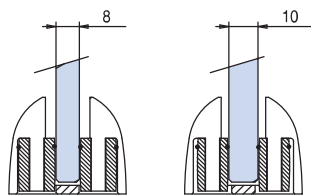

€▶A.632

xme022

V-052

- Guida a pavimento per vetro 8 e 10 mm. con feltrini
- Floor guide with felt strips for glass 8 and 10 mm
- Bodenführung mit Filzgleiter für Glas 8 und 10 mm
AN - NS

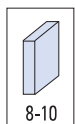

8-10

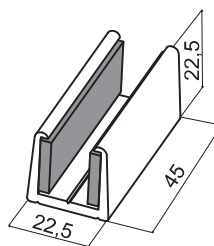

€▶A.631

FB059-A

V-099-C dx / V-099-C sx

- Doppia guida a pavimento destra o sinistra
- Double floor guide right or left
- Doppel Bodenführung rechts oder links
AN

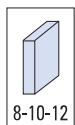

8-10-12

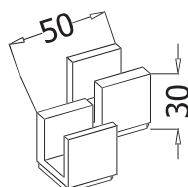

- Sinistra
- Left
- Links

- Destra
- Right
- Rechts

€▶A.633

xme425t

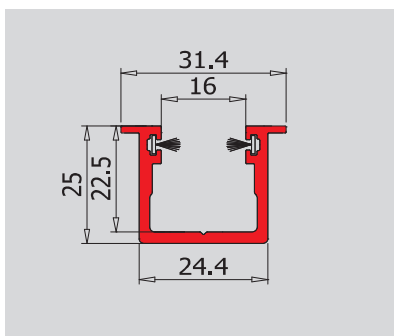
L-116

- Canalina da incassare a terra in alluminio compressa di spazzoline per vetro 10-12 mm
- Floor channel recessed installation with brush seals for glass 10-12 mm
- Bodenführung mit Bodenvorbereitung inkl. Bürstenprofile für Glasdicke 10-12 mm
AN

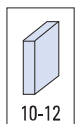

10-12

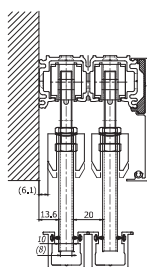
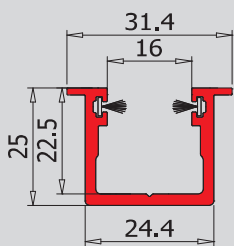

 Esempio
Example
Beispiel

€▶A.637

L-116

V-053

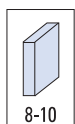
- Guida fermavetro in plastica
- Floor stopper in grey plastic
- Kunststoff-Bodenstopper, grau



8-10

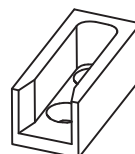

€▶A.639

V-053

175



P-013

- Profilino alluminio per chiusura arie scorrevole vetro mobile/vetro fisso con setola grigia, fissaggio tramite incollaggio
- Aluminium angled profile to reduce gaps between sliding door/fixed panel, with grey brush seal, to be glued on glass edge
- Aluminium Dichtungsprofil montiert auf der Glaskante

AN

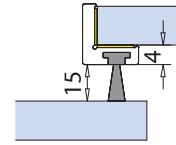
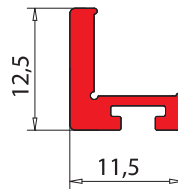
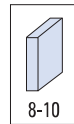

€▶ A.648

xme203-B



P-014

- Profilino alluminio per chiusura arie scorrevole vetro mobile/vetro fisso con spazzolino grigio, fissaggio tramite incollaggio
- Aluminium U profile to reduce gaps between sliding door/fixed panel, with grey brush seal, to be glued on glass edge
- Aluminium U Dichtungsprofil

AN

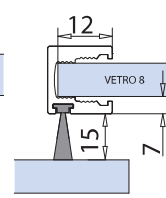
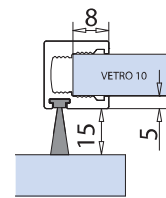
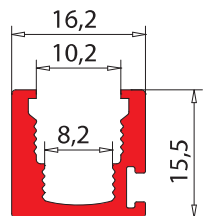
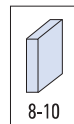

€▶ A.649

xme203-B



WRU-S 100/60 Z

- Guarnizione neutra per vetro 10/12 mm, fissaggio adesivo
- Neutral gasket for glass 10-12 mm with adhesive fixing
- Dichtungsprofil für 10-12 mm selbstklebend

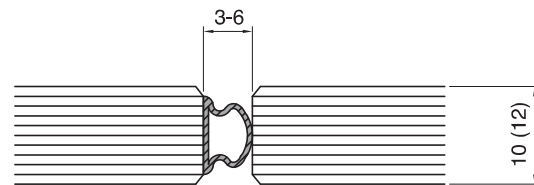
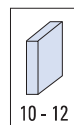

€▶ A.647



WRU-S 60/40 R

- Guarnizione neutra per vetro 8 mm, fissaggio adesivo
- Neutral gasket for glass 8 mm with adhesive fixing
- Dichtungsprofil für 8 mm. selbstklebend

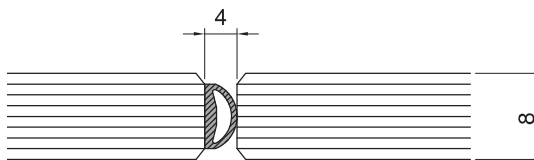
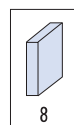

€▶ A.646



WRU-M 80/50

- Guarnizione neutra per vetro 8 mm, fissaggio adesivo
- Neutral gasket for glass 8 mm, with adhesive fixing
- Dichtungsprofil für 8 mm Glas, selbstklebend

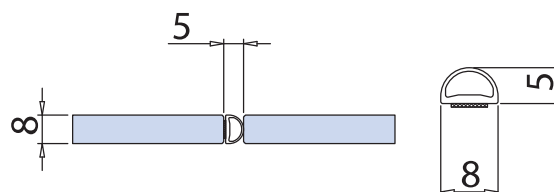
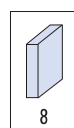

€▶ A.645

xfb-099

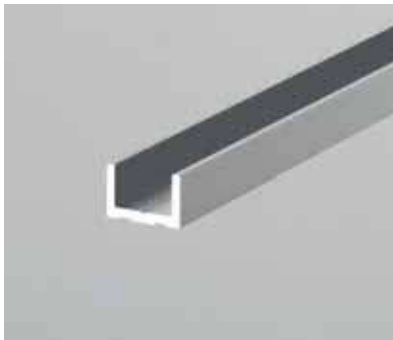

V-2015-MIX

- Canalina per vetro fisso, comprese guarnizioni per vetro 10 mm
 - U-channel for fixed panel, gaskets included for glass 10 mm
 - U-Profil für Seitenteil, Dichtungen enthalten für Glasdicke 10 mm
- AN - IXE

Misura / Length / Länge

2000 mm
3000 mm
6000 mm

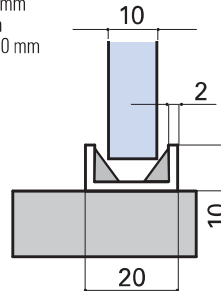

2mm

- Guarnizione nera inclusa
- Black gasket included
- Schwarze Dichtung enthalten

€▶A.641

V-2015

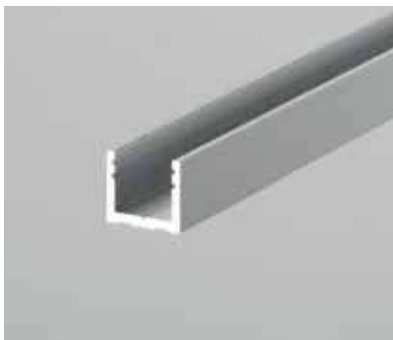

V-2014-MIX

- Canalina per vetro fisso, escluse guarnizioni
 - U-channel for fixed panel, gaskets not included
 - U-Profil für Seitenteil, Dichtungen nicht inkl
- AN - IXE

Misura / Length / Länge

2000 mm
3000 mm
6000 mm

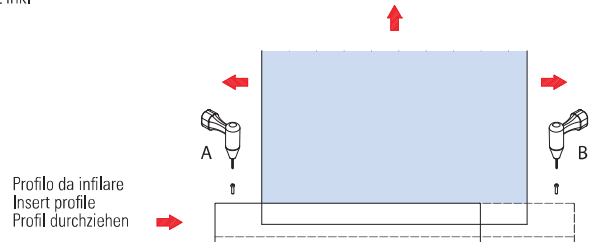
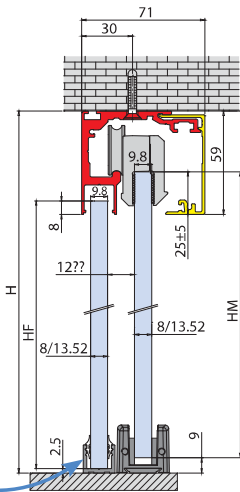
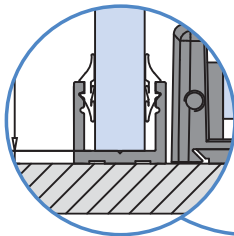

Guarnizioni
Gaskets
Dichtungen

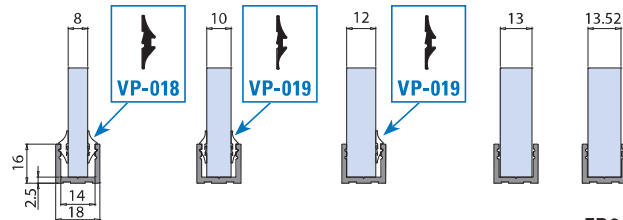

€▶A.640

FB044-E

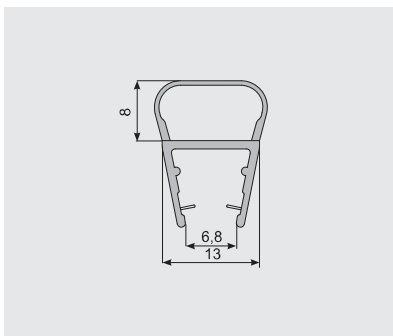

V-041

- Guarnizione a palloncino
- Gasket
- Dichtung

€▶A.644

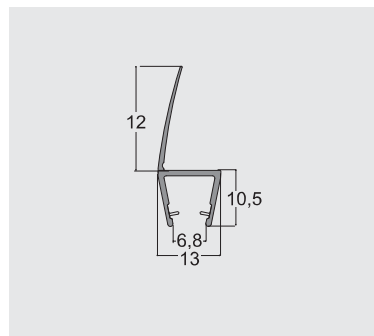
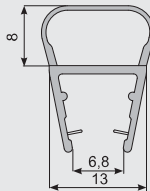

V-039

- Guarnizione per vetro 8-10 mm
- Gasket for glass 8-10 mm
- Dichtung für Glasdicke 8-10 mm

€▶A.642

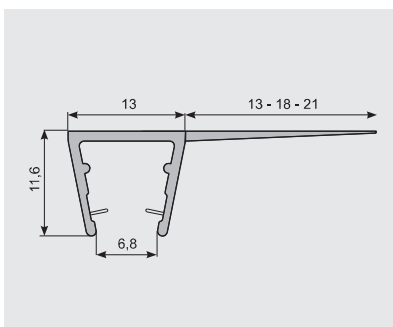
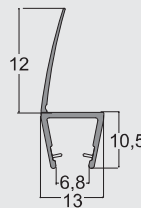

V-040

- ART. V-040/13
Guarnizione ala mm. 13
Gasket wing mm. 13
Dichtung mit Flügel mm. 13
- ART. V-040/18
Guarnizione ala mm. 18
Gasket wing mm. 18
Dichtung mit Flügel mm. 18
- ART. V-040/21
Guarnizione ala mm. 21
Gasket wing mm. 21
Dichtung mit Flügel mm. 21

€▶A.643

