

V-400 / MV-400

Materiale: Alluminio
Material: Aluminium



Dune V-1651
Maniglia / Handle / Griff

- Maniglie, cilindri e contropiastre da ordinare a parte.
- Handles, cylinders and strike plates not included, to order separately.
- Griffe, Zylinder und Schließbleche nicht enthalten, separat zu bestellen

V-400-UV



Blade V-1611
Maniglia / Handle / Griff

V-400-P



Le Mans V-1671
Maniglia / Handle / Griff

V-400-UV MV-400-UV

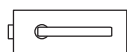

V-400-P MV-400-P

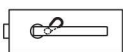

V-400-Pz MV-400-Pz

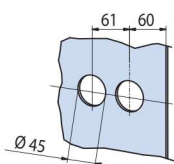
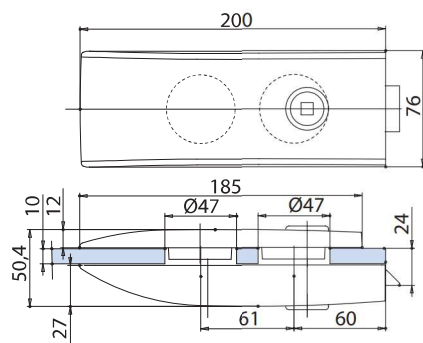
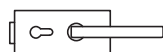

V-900-2FLG

MV-900-2FLG

- Controserratura
- Strike box
- Gegenkasten

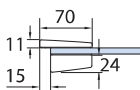
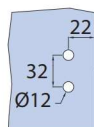
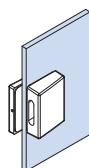
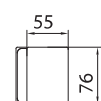
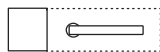

- Cerniere
- Hinges
- Bänder
- ▶ 118

V-401



V-403



xla33 / xme692

NS
Nichel satinato
Satin nickel
Ähnlich Edelstahl matt

CS
Cromo satinato
Satin chrome
Chrom matt

CR
Cromo lucido
Polished chrome
Chrom glänzend

MV
Versione magnetica
Magnetic version
Mit magnetischem Schließvorgang