

MINIMA 55 LEVER



V-584 €►E.212



V-585 €►E.213



- Serrature Minima 55 Lever con gancio per scorrevole o chiavistello tondo. Cilindri e contropiastre da ordinare a parte.
- Locks Minima 55 Lever with hook for sliding doors or with rounded dead bolt. Cylinders and strike plates not included, to order separately.
- Minima 55 Lever Schlösser mit Hakenriegel für Schiebetüren oder Mittelschloss mit Bolzen. Zylinder und Schließbleche nicht enthalten, separat zu bestellen.

SERRATURE

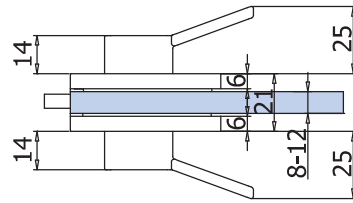
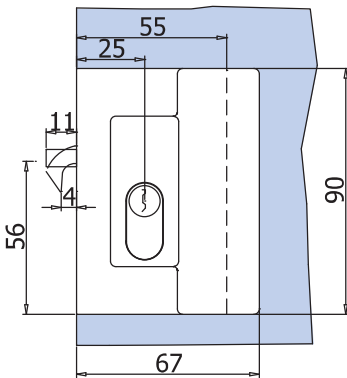

xme 496

LAVORAZIONE VETRO
GLASS PREPARATION
GLASBEARBEITUNG

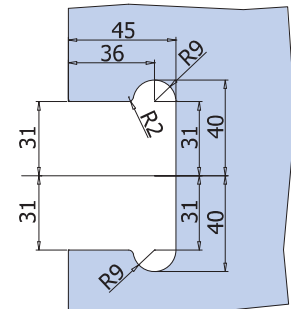

C-020 €►E.215

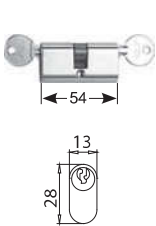

C-021 €►E.216

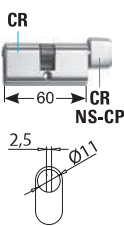

C-019 €►E.217

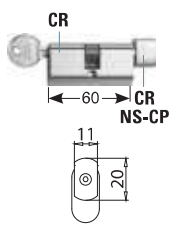

V-569 2FLG €►E.214

- Controserratura
- Strike box
- Gegenkasten

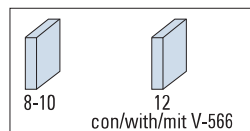
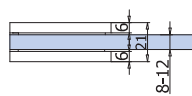
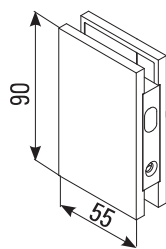
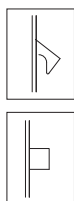

V-566 €►E.221

- Spessore per vetro 12 mm
- Spacer for glass thickness 12 mm
- Distanzscheibe für Glasdicke 12 mm

V-568 €►E.218

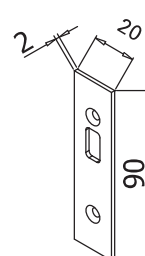

V-567 DX €►E.219

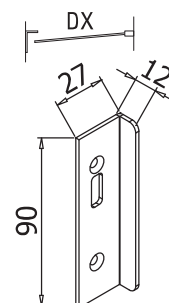

V-567 SX €►E.220

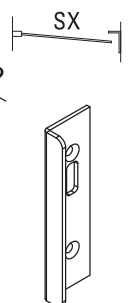

CP
Cromo perla
Chrome perla similar Alu
Chrom perla ähnlich Alu

NS
Nickel satinato
Satin nickel
Ähnlich Edelstahl matt

CR
Cromo lucido
Polished chrome
Chrom glänzend