

MINIMA 55 RIBASSATA



V-574 €►E.244



V-575 €►E.245



- Serrature Minima 55 Ribassata con gancio per scorrevole, chiavistello tondo e scrocco ad olivetta. Cilindri e contropiastre da ordinare a parte
- Locks Minima 55 Lowered with Hook for sliding doors, with rounded dead bolt or with double bevelled latch. Cylinders and strike plates not included, to order separately.
- Minima 55 abgerundete kante mit Hakenriegel für Schiebetüren oder Mittelschloss mit Bolzen. Zylinder und Schließbleche nicht enthalten, separat zu bestellen.

SERRATURE

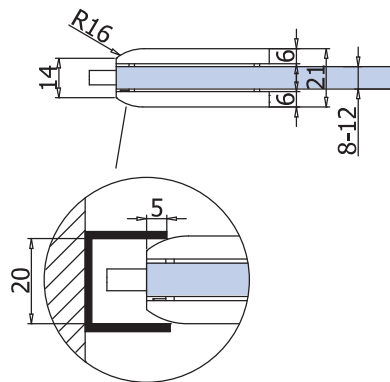
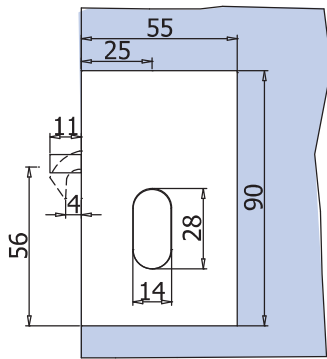

LAVORAZIONE VETRO
GLASS PREPARATION
GLASBEARBEITUNG

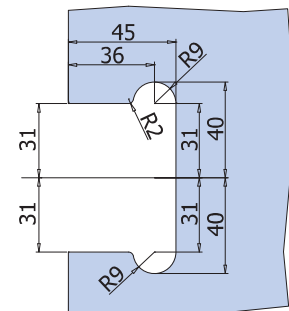

xme 445

C-010

€►E.247

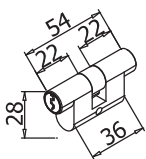

C-011

€►E.248

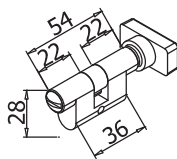

C-012

€►E.249

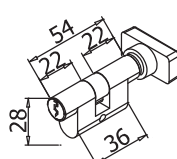

V-569 2FLG €►E.246

- Controserratura
- Strike box
- Gegenkasten

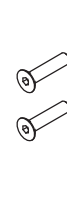
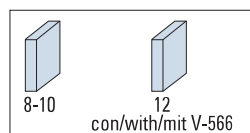
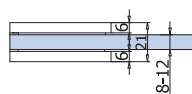
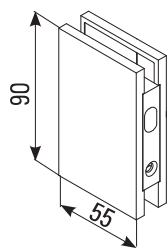
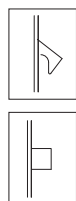

V-566 €►E.253

- Spessore per vetro 12 mm
- Spacer for glass thickness 12 mm
- Distanzscheibe für Glasdicke 12 mm

V-568

€►E.250

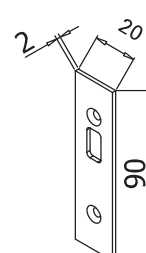

V-567 DX

€►E.251

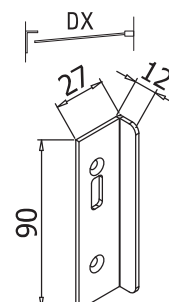

V-567 SX

€►E.252

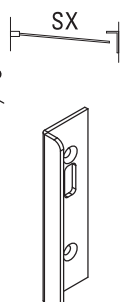

CP
Cromo perla
Chrome perla similar Alu
Chrom perla ähnlich Alu
110

NS
Nickel satinato
Satin nickel
Ähnlich Edelstahl matt

CR
Cromo lucido
Polished chrome
Chrom glänzend