

DISTANZIALI REGOLABILI TONDI Ø 48 / 40 mm

ROUND ADJUSTABLE POINT FITTINGS Ø 48 / 40 mm / RUNDE VERSTELLBARE PUNKTHALTERUNGEN Ø 48 / 40mm





DR-048 30-40

IX
Materiale / Material / Material:
Inox AISI 316

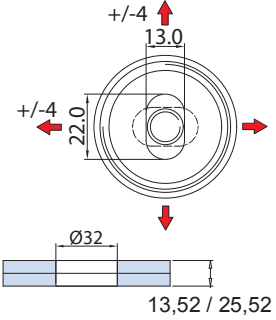
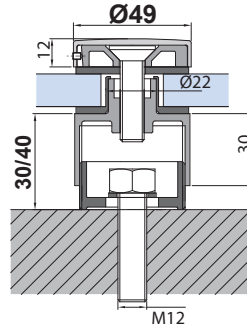

Foro nel vetro
Glass hole
Glasbohrung

xme607a

Incluso / Included / Inkl.
M12x80



DR-048 40-50

IX / IL
Materiale / Material / Material:
Inox AISI 316

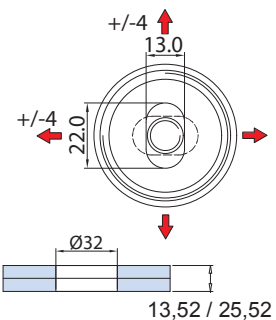
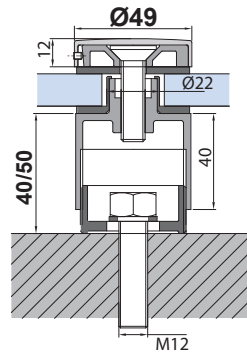

Foro nel vetro
Glass hole
Glasbohrung

xme607a

Incluso / Included / Inkl.
M12x80



DR-048 50-60

IX
Materiale / Material / Material:
Inox AISI 316

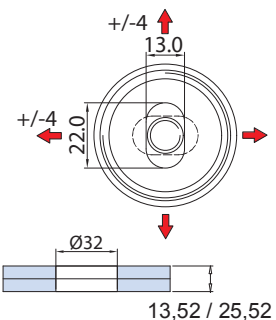
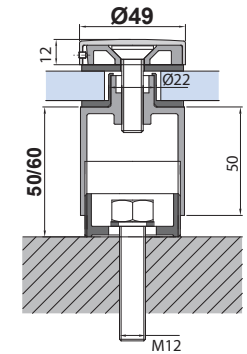

Foro nel vetro
Glass hole
Glasbohrung

xme607a

Incluso / Included / Inkl.
M12x80



DR-040 40-50

IX
Materiale / Material / Material:
Inox AISI 316

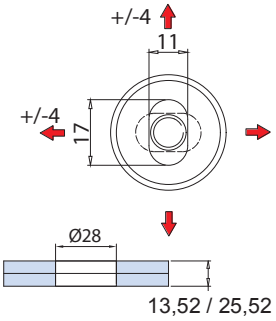
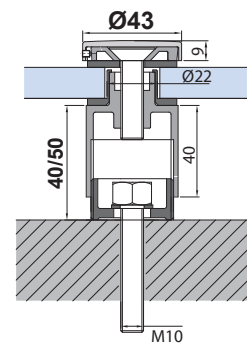

Foro nel vetro
Glass hole
Glasbohrung

xme607b

Incluso / Included / Inkl.
M10x80

- Regolazione in profondità con vetro montato.
- Depth adjustment with installed glass.
- Tiefeneinstellung mit eingebautem Glas.

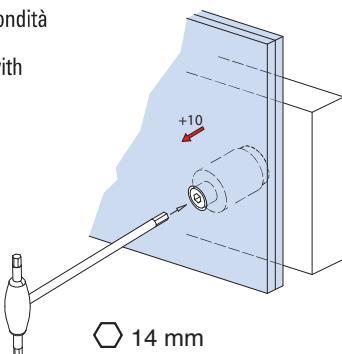

- Regolazione
- Adjustment
- Einstellung

