

CERNIERE TUTT'ALTEZZA

HINGES PROFILES / BANDPROFILE



P-08

€ E.376

- Cerniera tutt'altezza ad incollaggio per applicazione su stipiti battuta da 40 mm. Altezza standard cerniera 2400 mm.
- Hinge profile. Glass to be glued. For frames with rebate depth 40 mm. Hinge standard height 2400 mm.
- Bandprofil (Glas wird geklebt) für Falztiefe 40 mm. Band standard Höhe 2400 mm.

AN

L=2400 mm

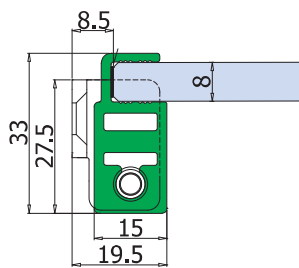
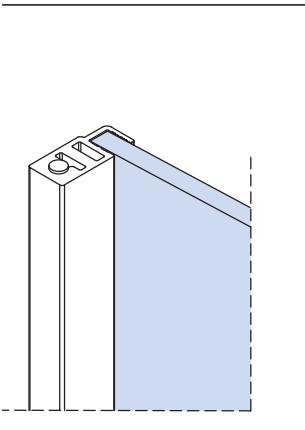
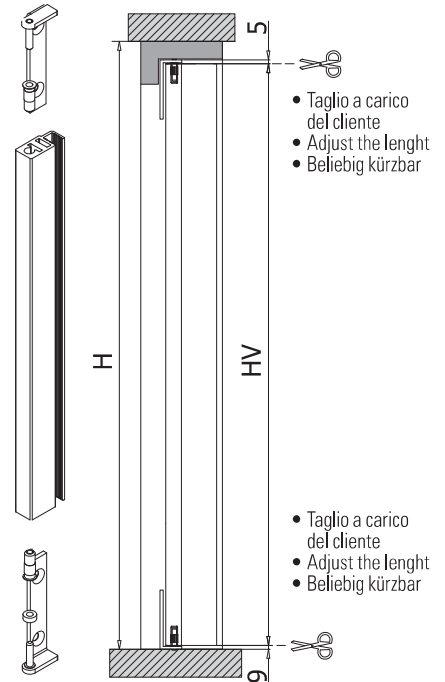

SW DP 105 (3M) / SW DP 610 (3M)

- Adesivo strutturale consigliato.
- Suggested structural glue.
- Empfehlung Klebstoff.

V-121-SD (incluso / included / enthalten)

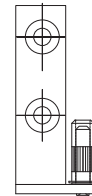
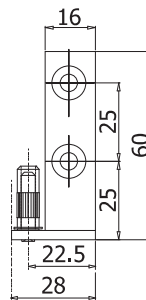

DX

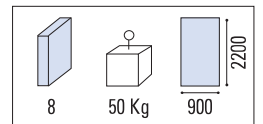

Cerniera applicabile ai seguenti stipiti / Hinge available for following frames / Band an folgende Zargen montierbar

P-030 / P-040

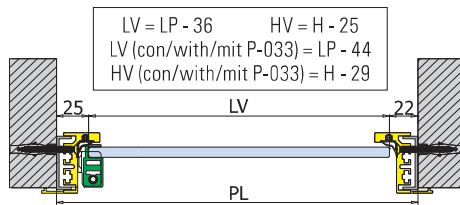
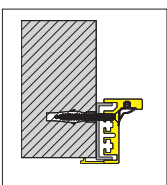

TP-250

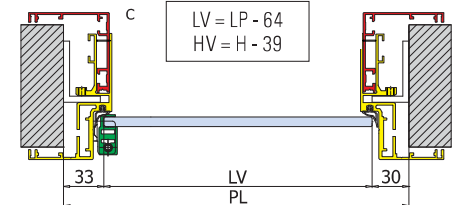
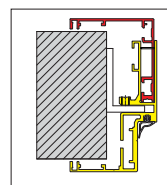

TP-100

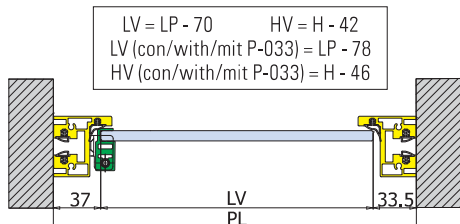
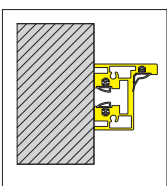

P-070

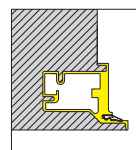

P-060

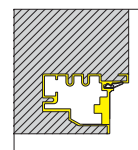

TP-201

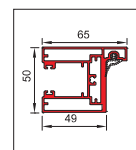

TP-300

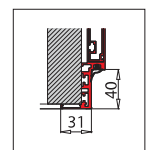

LP Passaggio luce Clear opening width Lichte Durchgangsbreite	LV Larghezza vetro Glass width Glasbreite	HV Altezza vetro Glass height Glashöhe	H Altezza passaggio luce Clear opening height Lichte durchgangshöhe
---	---	--	---