

## CORRIMANO / HANDRAIL PROFILE / HANDLAUF PROFILE

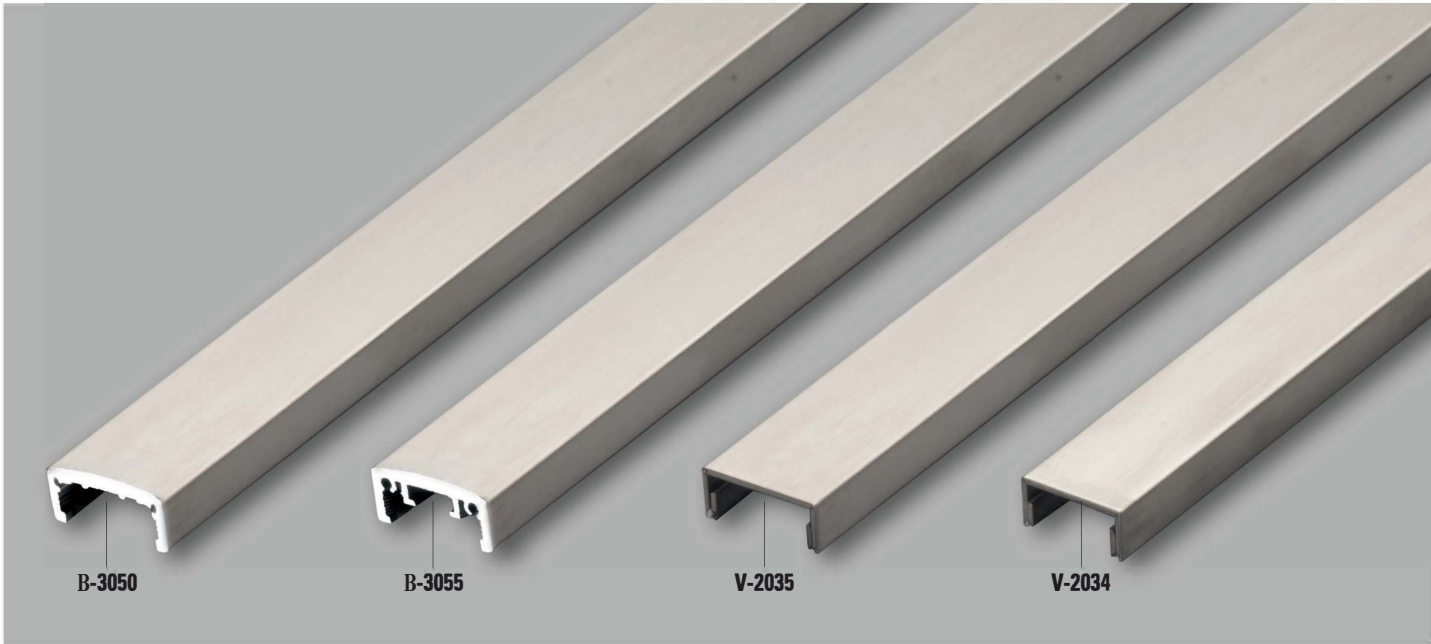

### B-3050 / B-3055

- Corrimano in alluminio ad incollaggio
- Edge protection profile in aluminium
- Kantenschutzprofil aus Aluminium



► 100

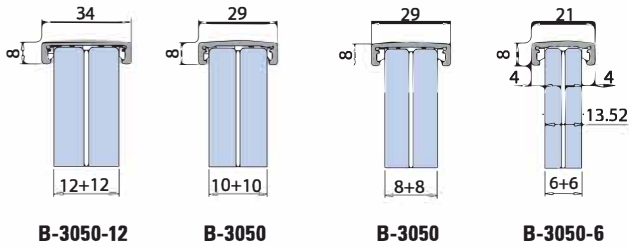

**B-3050-12**

**B-3050**

**B-3050**

**B-3050-6**

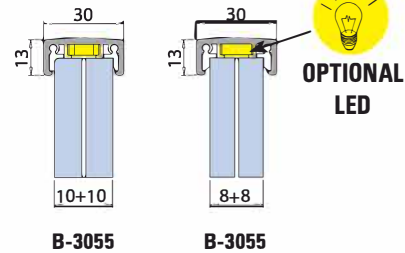

**B-3055**

**B-3055**

### V-2034 / V-2035

- Profili di protezione inox AISI 316
- Edge protection inox AISI 316
- Kantenschutz inox AISI 316

► 101

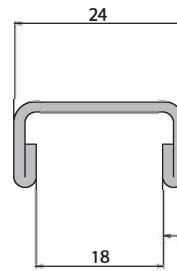

**V-2034**

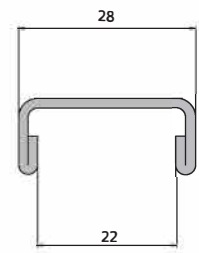

**V-2035**

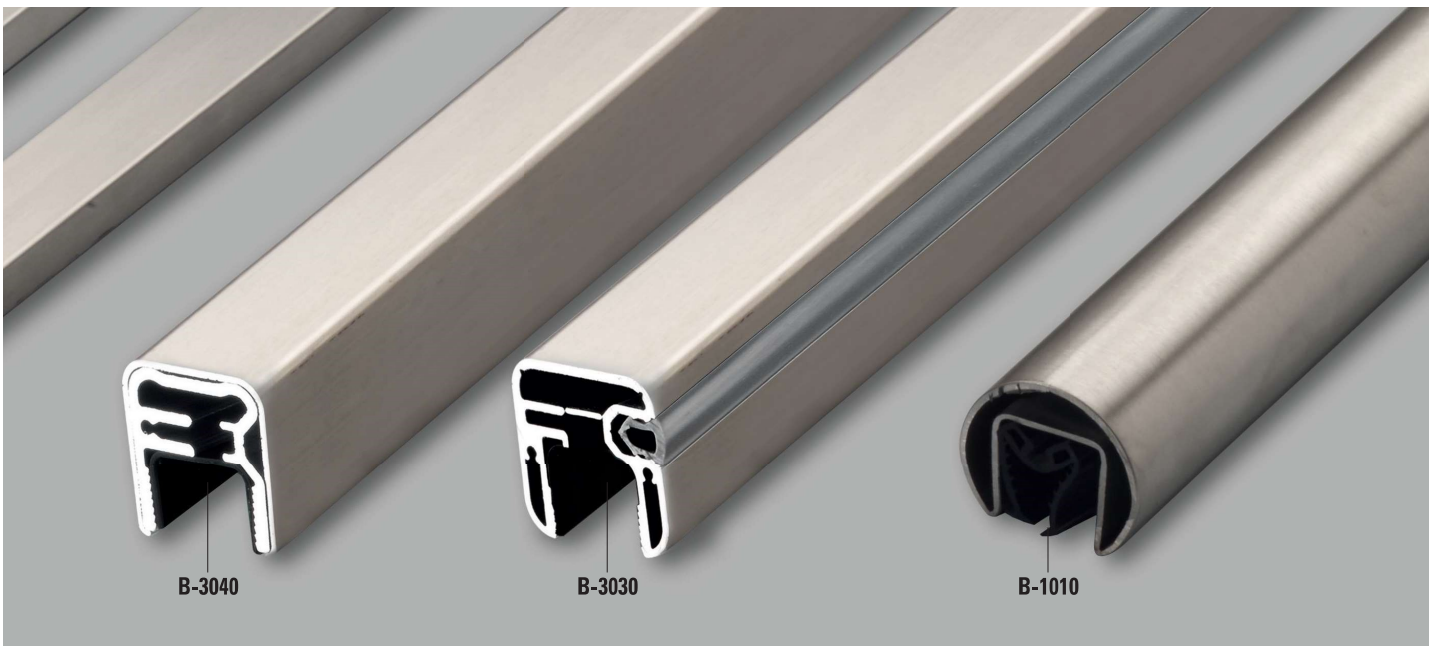

**B-3040**

- Corrimano quadro
- Square handrail profile
- Eckiger Handlauf

► 102

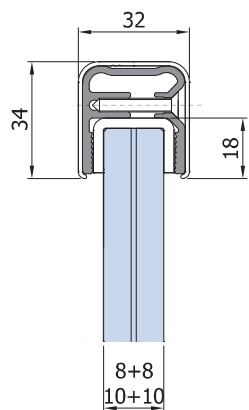
**B-3030**

- Corrimano tondo
- Round handrail profile
- Runder Handlauf

► 103

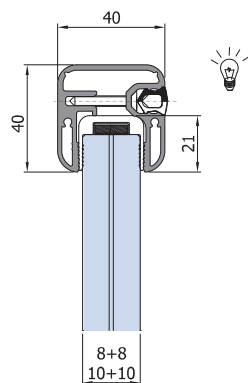

**B-1010**

- Tubo profilo ad "u" scanalato
- Glass channel tube
- Glasleistenrohr
- IX

► 104

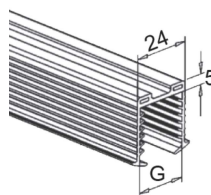
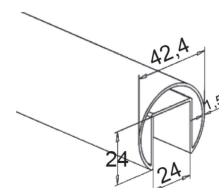

L=3000

**B-1015-17,5**

- Guarnizione in caucciù per tubo scanalato per vetro 17,5 mm.
- Rubber profile for channel tube for glass 17,5 mm.
- Gummiprofil für Glasleistenrohr für Glas 17,5 mm.

**B-1015-21,5**

- Guarnizione in caucciù per tubo scanalato per vetro 21,5 mm.
- Rubber profile for channel tube for glass 21,5 mm.
- Gummiprofil für Glasleistenrohr für Glas 21,5 mm.



## V-2034 / V-2035 PROFILI DI PROTEZIONE INOX AISI 316

### EDGE PROTECTION INOX AISI 316 / KANTENSCHUTZ INOX AISI 316

**IX**  
Acciaio inox satinato  
Satin stainless steel  
Edelstahl matt

**IL**  
Acciaio inox lucido  
Polished stainless steel  
Edelstahl poliert



#### V-2034 €

- Corrimano in acciaio inox aisi 316, per vetro 8+8+1,52 L = 3000 mm
- Handrail stainless steel aisi 316 for glass 8+8+1,52 L = 3000 mm
- Kantenschutz aus Edelstahl aisi 316 für 8+8+1,52 L = 3000 mm

IX-IL

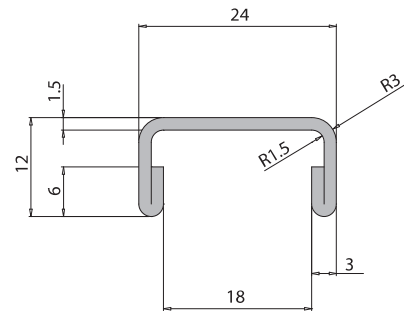
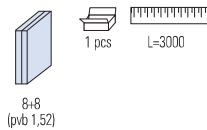

#### V-2035 €

- Corrimano in acciaio inox aisi 316, per vetro 10+10+1,52 L = 3000 mm
- Handrail stainless steel aisi 316 for glass 10+10+1,52 L = 3000 mm
- Kantenschutz aus Edelstahl aisi 316 für 10+10+1,52 L = 3000 mm

IX-IL

