

# ACCESSORI PER PORTE

## ACCESSORIES FOR DOORS / ZUBEHÖRE

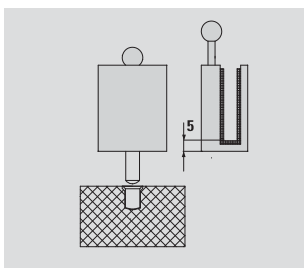

- V-003-08**  
**V-003-10** € E.336
- Catenacciolo per porta doppia, vetro 8 mm. o 10 mm
  - Locking bolt down for double door glass 8 mm. or 10 mm.
  - Feststeller für Glas 8 - 10 mm  
CS - NS - CR - OL - CP

V-003

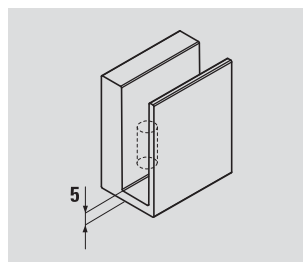

- V-003-2FLG-08**  
**V-003-2FLG-10** € E.338
- Catenacciolo per porta doppia, vetro 8 mm. o 10 mm
  - Locking bolt down for double door glass 8 mm. or 10 mm.
  - Feststeller für Glas 8 - 10 mm  
CS - NS - CR - OL - CP

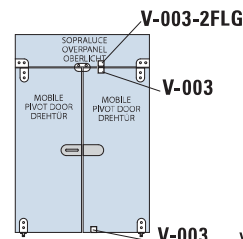

V-003-2FLG



- V-004** € E.337
- Catenacciolo porta doppia.
  - Locking bolt for double door.
  - Türschnäpper für 2-flg  
CS

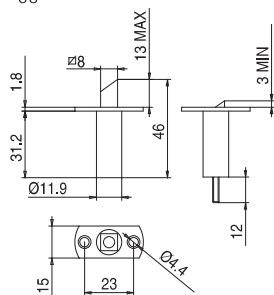

xla56b

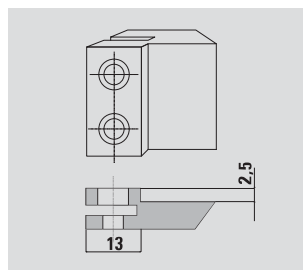

- V-001** € E.339
- Scrocco fresato 2,5 mm. per serrature V-200 / V-200 ECO / V-400 / V-720
  - Latch 2,5 milled for locks V-200 / V-200 ECO / V-400 / V-720
  - Falle abgesetzt für Schlösser V-200 / V-200 ECO / V-400 / V-720

- V-001 B**
- Scrocco fresato per serrature V-230 / V-730
  - Milled latch for locks V-230 / V-730
  - Falle abgesetzt für Schlösser V-230 / V-730

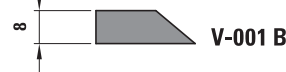

V-001



- P-F07** € E.340
- Piastra di fissaggio cardini su stipiti legno norme tedesche DIN NORM.
  - Admission for frame part wooden frame with four screws.
  - Aufnahmeelement für Rahmenteil für Holzargen mit 4-fach Verschraubung.

xla53

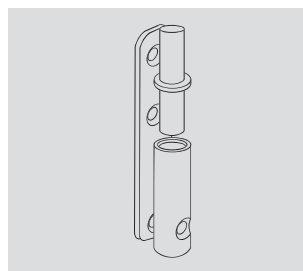

- P-F01** € E.341
- Perno con piastra fissaggio per cerniere V-201, V-201 ECO, V-401, V-102.
  - Pivot with fixing plate for hinges V-201, V-201 ECO, V-401, V-102.
  - Aufschraub-rahmenteil für V-201, V-201 ECO, V-401, V-102 Bänder.

P-F01

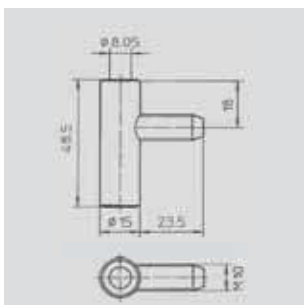

- C-08** € E.318
- Cardine per stipiti metallici norme austriache, per cerniere V-402, V-702.
  - Frame part for rebated doors on steel frame. Ready for use: For hinge V-402/V-702, german type - Load capacity: 70 kg
  - Rahmenteil für Gefälzte türen an Ö-Norm Stahlzargen. Einsatz: Für Glastürband V-402/V-702 verwendbar, 3teilige Bänder - Türgewicht: 70 kg

V-8000 1

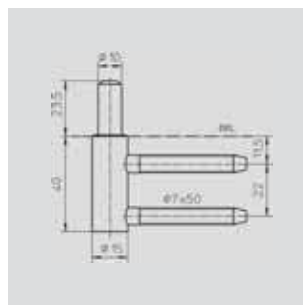

- P-F02** € E.343
- Cardine per stipiti legno norme tedesche per cerniere V-201, V-401, V-201 eco, V-102
  - Frame part for rebated doors on wooden frame Ready for use: for hinge V-201/V-401/V-201eco/V-102, german type - Load capacity: 70 kg
  - Rahmenteil für Gefälzte türen an Holzargen DIN-NORM Einsatz: für Glastürband V-201/V-401/V-201eco/V-102 verwendbar, 2teilige Bänder - Türgewicht: 70 kg

V-3400WF

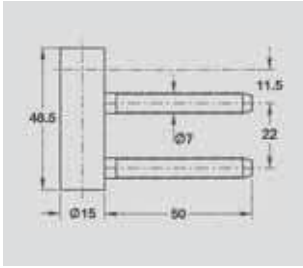

**P-F03**

€ ▶ E.345

- Cardine per stipiti legno norme tedesche DIN-NORM per cerniere V-402, V-702.
- Frame part for rebated door on wooden frame. Ready for use: for hinge V-402/V-702 german type. Load capacity: 70 kg
- Rahmenteil für Gefälzte türen an Holzargen. Einsatz: für Glastürband V-402/V-702 verwendbar, 3teilige Bänder - Türgewicht: 70 kg

v-4400 graf

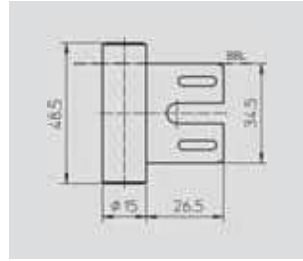

**P-F04**

€ ▶ E.344

- Cardine per stipiti metallici norme tedesche DIN-NORM per cerniere V-402, V-702
- Frame part for rebated door on steel frame. Ready for use: For hinge V-402/V-702 economy, german type
- Rahmenteil für Gefälzte türen an DIN-NORM Stahlargen Einsatz: Für Glastürband V-402/V-702 verwendbar, 3teilige Bänder - Türgewicht: 70 kg

V-8000 1 graf



**01999**

€ ▶ E.346

- Fermaporta Ø 57,2 mm. x 25 h
- Door stopper Ø 57,2 mm. x 25 h
- Türstopper Ø 57,2 mm. x 25 h IX

xla56b



**02002**

€ ▶ E.347

- Fermaporta Ø 32 X 37 h
- Door stopper Ø 32 mm. x 37 h
- Türstopper Ø 32 X 37 h IX

V-001



**L-111**

€ ▶ E.349

- Pozzetto eccentrico a pavimento
- Eccentric floor socket
- Exzenterbuchse verstellbar CS

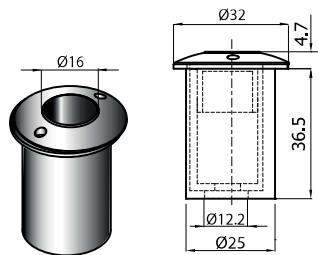

L-111 graf



**L-112**

€ ▶ E.348

- Pozzetto eccentrico a pavimento con tappo a molla antipolvere
- Eccentric floor socket with spring and dust cover
- Exzenterbuchse verstellbar mit Schutzabdeckung CS

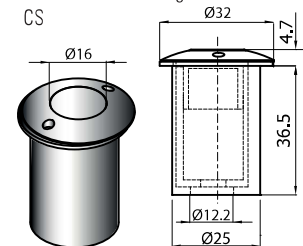

L-112.AI



**L-112-PA**

€ ▶ C.06

- Pozzetto eccentrico a pavimento con tappo a molla antipolvere per sistemi a parcheggio
- Eccentric floor socket with spring and dust cover for parking system
- Exzenterbuchse verstellbar mit Schutzabdeckung für Ganzglas-Schiebewandsysteme CS

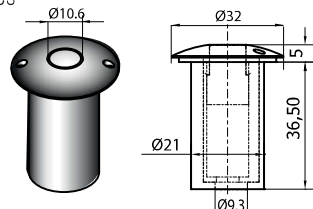

L-112-PA



**V-026**

€ ▶ E.351

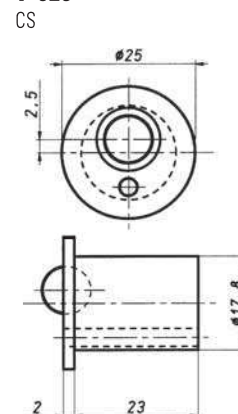

xla144



**V-027**  
CS

€▶ E.352

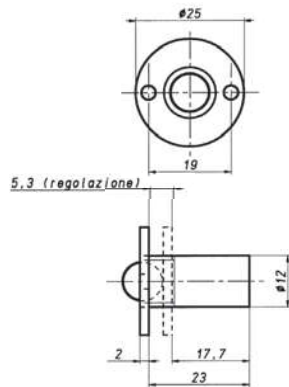

xla144



**V-025**  
CS

€▶ E.350

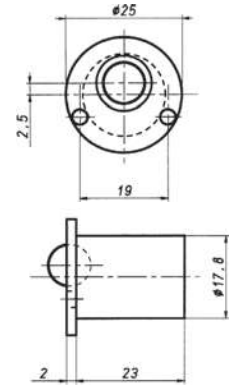

xla144



**V-028**

€▶ E.353

- Cricchetto centrale regolabile con piastrina ovale Ø 12 mm.
- Adjustable roller bolt with oval rose - Ø 12 mm
- Türschnäpper verstellbar Ø 12 mm - mit ovale Rosette CS

xla144



**V-029**

€▶ E.354

- Cricchetto doppio regolabile diam. 12 x 2 mm - doppie sfere, interasse 15 mm
- Double adjustable roller bolt Ø 12 x 2 mm
- Doppel-türschnäpper verstellbar Ø 12 mm x 2 CS

xla144

## ACCESSORI PER VETRINE

### ACCESSORIES FOR DISPLAY CABINETS / ZUBEHÖRE FÜR SCHAUFENSTERAUSLAGE



**B-309**

€▶ E.354.1

- Cerniere per vetrina.
- Hinges for display cabinet.
- Bänder für Schaufensterauslage.

CR - NS