

SLIDING COLLECTION

A defined line, identical on the 4 sides, determines the perimeter of the light and of every reflection.
A clean and defined vision... FRAMED SLIDING DOORS.

Eine klar definierte Linie, die auf allen vier Seiten identisch ist, um den Umfang des Lichts und jeder Reflexion zu bestimmen. Eine klare und reine Vision... GERAHMTE SCHIEBETÜREN.

Una línea definida, idéntica en los 4 lados, para determinar el perímetro de la luz y de cada reflejo. Una visión definida y pura... PUERTAS DESLIZANTE ENMARCADAS.

Une ligne définie, identique sur les 4 côtés, pour établir le périmètre de lumière et de chaque reflet. Une vision élaboré et pure... PORTES COULISSANT À CADRE.



DIV
 PANEL - TÜR - PUERTA - PORTE

DIV-204
 CROSS PROFILE - QUERPROFIL - TRAVESAÑO
 - TRAVERSE

BI
 FINISHING - OBERFLÄCHE - ACABADO
 - FINITION

DIV-7600 Ri-EVOLUTION
 INVISIBLE SYSTEM FOR SUSPENDED
 CEILING
 SYSTEM FÜR ABGEHÄNGTE DECKE
 SISTEMA INVISIBLE EMPOTRADO EN EL TECHO
 SYSTEME INVISIBLE ENCASTRE
 DANS LE PLAFOND

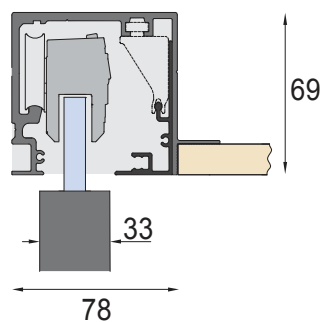

SLIDING COLLECTION

VERSIONS - VERSIONEN - VERSIONES - VERSIONS



STRUCTURE in extruded aluminium with double-sided adhesive

STRUKTUR strangepresstes Aluminium, selbstklebend

ESTRUCTURA aluminio estruido con bi-adhesivo

STRUCTURE en aluminium extrudé avec bande adhésive double face

GLASS for 10 mm (tempered) or 10.38 mm (laminated)

GLAS geeignet für 10 mm ESG oder 10,38 mm VSG

VIDRIO preparado para 10 mm templado o 10.38 mm laminado

Pour verre trempé de 10 mm ou feuilleté de 10,38 mm

CROSS PROFILE in extruded aluminium with double-sided adhesive

QUERPROFIL strangepresstes Aluminium, selbstklebend

TRAVESAÑO aluminio estruido con bi-adhesivo

TRAVERSES en aluminium extrudé avec ruban adhésif double face

PROFILE DIMENSION - PROFILGRÖSSE - DIMENSIONES DE PERFILES - DIMENSION DES PROFILS

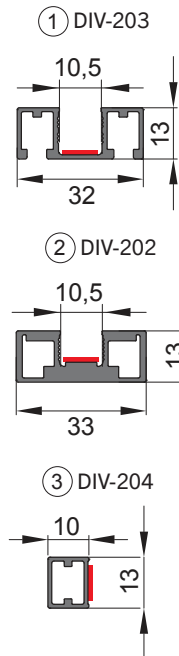

Pre-installed double-sided adhesive
Selbstklebend
Bi-adhesivo preinstalado
Ruban adhésif double face préinstallé

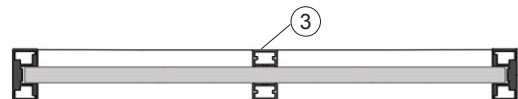
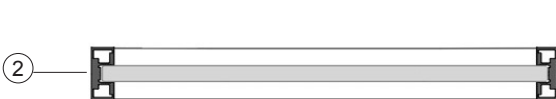

SLIDING DOORS

EXCLUSIVE FEATURES OF THE PROJECT

EXKLUSIV FÜR DAS PROJEKT - EXCLUSIVO DEL PROYECTO - PROJET EXCLUSIF

- Use of the exclusive MyMetalglas program for door design. **Glass measurements, profiles and processes with a single click.**
- *Nutzung des exklusiven Programms MyMetalglas für die Türplanung. Glasabmessungen, Profile und Verarbeitungen mit einem Klick.*
- *Utilización del programa exclusivo MyMetalglas para el desarrollo de puertas. Medidas, perfiles y procesos de vidrio con un solo clic.*
- *Utilisation du programme exclusif MyMetalglas pour le développement des portes. Mesures du verre, des profils et usinage en un seul clic.*
- Pre-installed double-sided adhesive. **Straightforward assembly without the use of any type of glue. NO glass cleaning.**
- *Selbstklebend. Sofortige Montage ohne die Verwendung von Klebstoff jeglicher Art. Glasreinigung NICHT MEHR NOTWENDIG.*
- *Bi-adhesivo preinstalada. Montaje inmediato sin el uso de ningún tipo de cola. Eliminación total de limpieza de cristales.*
- *Adhésif double face préinstallé. Montage simple sans l'utilisation de d'aucun type de colle. PAS de nettoyage du verre.*
- Drilling template: cut the profiles as per our specifications and use the drilling template to make error-free holes.
- *Bohrschablone: schneiden Sie die Profile und bohren Sie mit der Schablone ohne Fehlerrisiko.*
- *Plantilla de taladrado: corta los perfiles de nuestra lista y con la plantilla de taladrado sin posibilidad de errores.*
- *Gabarit de perçage: découpez les profils selon nos spécifications et utilisez le gabarit de perçage pour réaliser des trous sans erreur.*

FINISHING RANGE

OBERFLÄCHEN-SORTIMENT - GAMA DE ACABADOS - GAMME DE FINITION



INOX EFFECT

INOX EFFEKT
EFECTO ACERO
INOXIDABLE SATINADO
EFFET ACIER
INOX SATINE

XO

LIGHT BRONZE

HELLBRAUN
BRONZE CLARO
BRONZE CLAIR

BC

DARK BRONZE

DUNKELBRAUN
BRONZE OSCURO
BRONZE FONCE

BS

SILVER ANODIZED

ALUMINIUM
SILBERFARBIG
ANODIZADO NATURAL
ANODIZE NATURAL

AN

MATT WHITE

WEISS MATT
BLANCO MATE
BLANC MAT

BI

MATT BLACK

SCHWARZ MATT
NEGRO MATE
NOIR MAT

NO



A winning, fast and safe system for aligning and assembling profiles.
 Ein optimales, schnelles und sicheres System zur Profilausrichtung und -montage.
 Un sistema ganador, rápido y seguro para la alineación y montaje de perfiles.
 Un système performant, rapide et sûr pour aligner et assembler les profilés.

PANEL SET

DIV-995

995 x 2980 mm

DIV-1495

1495 x 2980 mm

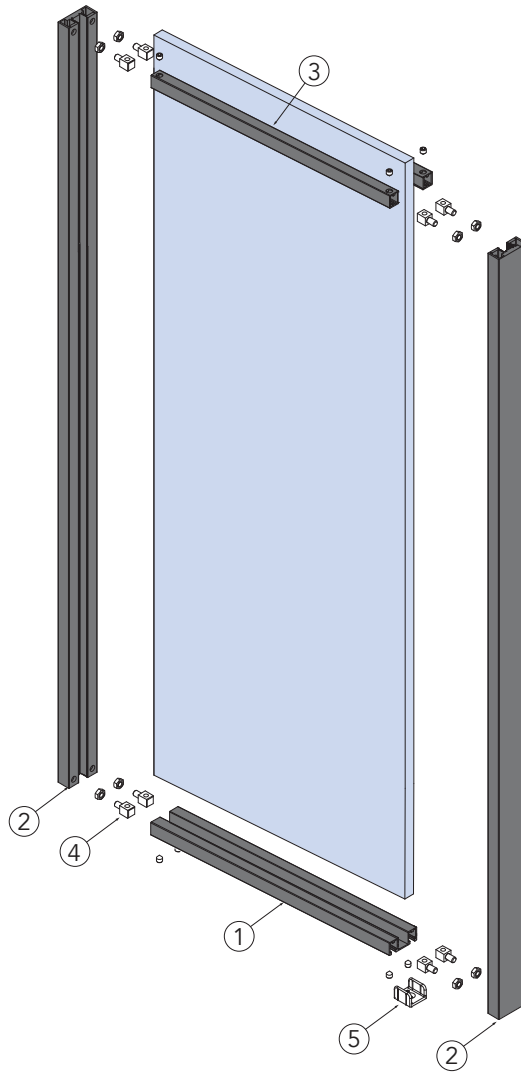

① Horizontal bottom profile DIV-203

Unterer Horizontalprofil DIV-203
 Transversal inferior DIV-203
 Traverse inférieure DIV-203

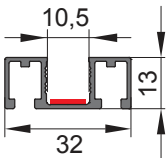

② Vertical profile DIV-202

Vertikalprofil DIV-202
 Vertical DIV-202
 Profil vertical DIV-202

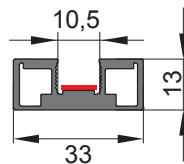

③ Cross profile DIV-204

Querprofil DIV-204
 Travesaño DIV-204
 Traverse DIV-204

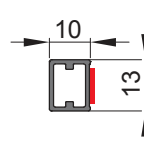

④ Assembly kit P-F37

Montage-Kit P-F37
 Kit de montaje P-F37
 Kit de montage P-F37

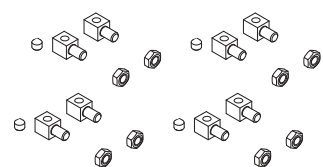

⑤ Door guide DIV-012

Bodenführung DIV-012
 Guía de puerta DIV-012
 Guide de la porte DIV-012



⑥ DRILLING TEMPLATE DIV-01

Bohrschablone DIV-01
 Plantilla de perforado DIV-01
 Gabarit de perçage DIV-01

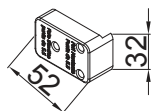

 Pre-installed double-sided adhesive
 Selbstklebend
 Bi-adhesivo preinstalado
 Ruban adhésif double face préinstallé

DIV

Framed panel - *Gerahmte Tür* - *Puerta enmarcada* - *Porte à cadre*

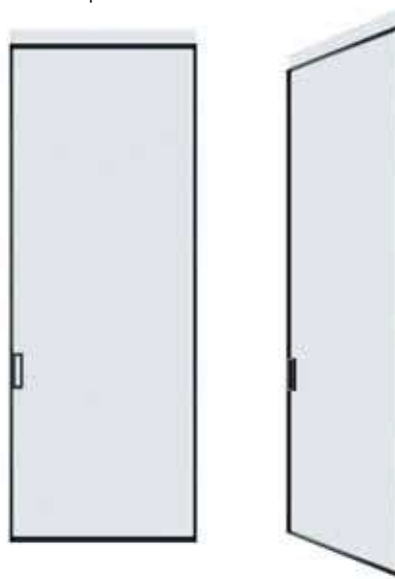
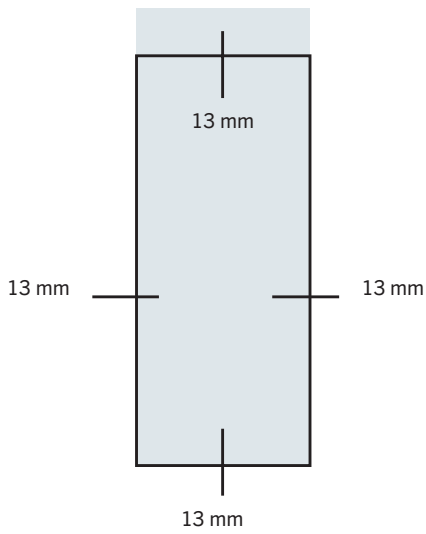

Framed panel with horizontal cross profiles - *Gerahmte Tür mit Querleisten* - *Puerta enmarcada con listones transversales* - *Porte à cadre avec moulures transversales*

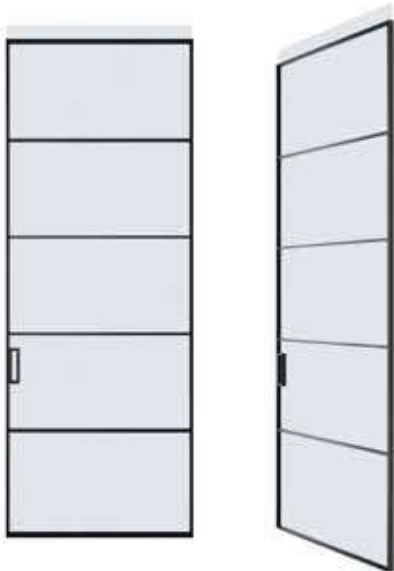

Framed panel with horizontal and vertical cross profiles - *Gerahmte Tür mit Quer und Vertikalleisten* - *Puerta enmarcada con listones transversales y verticales* - *Porte à cadre avec moulures transversales et verticales*

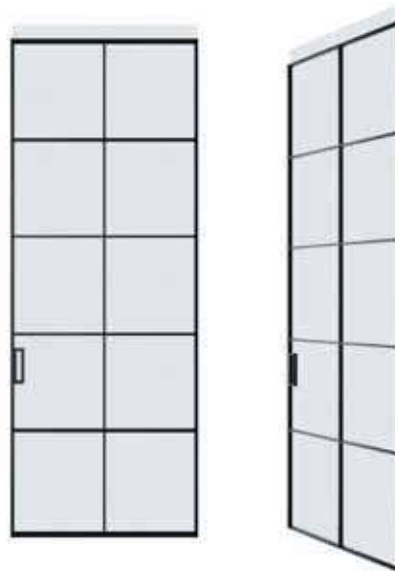

Framed panel with vertical cross profiles only - *Gerahmte Tür nur mit Vertikalleisten* - *Puerta enmarcada con listones todos verticales* - *Porte encadrée avec toutes les moulures verticales*



Framed panel with horizontal cross profiles only - *Gerahmte Tür nur mit Querleisten* - *Puerta enmarcada con listones todos transversales* - *Porte à cadre avec toutes les moulures*



SLIDING FRAMED DOOR

SET FIXED PANEL

DIV-FIX-995
995 x 2980 mm
DIV-FIX-1495
1495 x 2980 mm

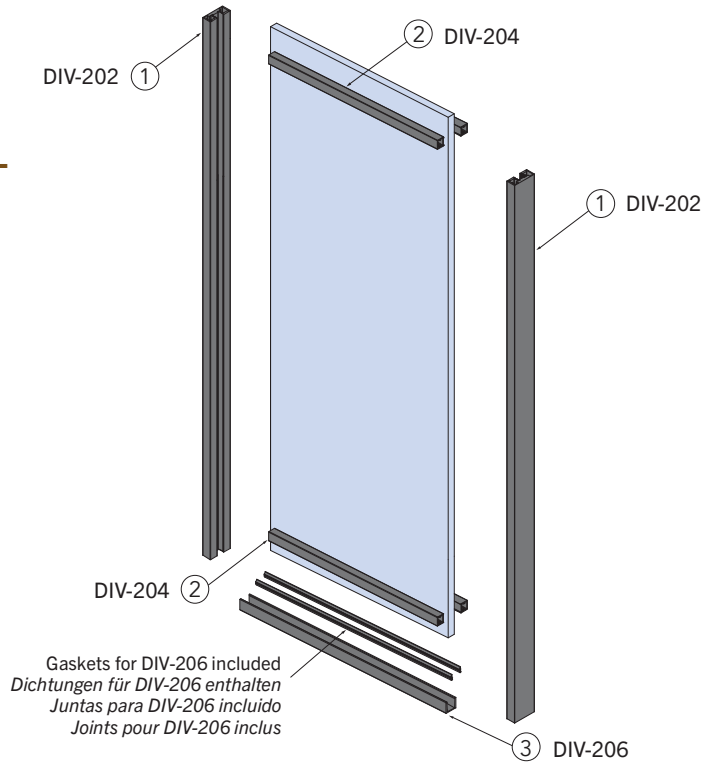

xme597g

HANDLES - GRIFFE - MANILLAS - POIGNEES

Technical pages - Technische Seiten - Páginas Técnicas - Pages Techniques ▶ 80

DIV-007

DIV-008

DIV-009
Lock - Schloss - Cerradura
de la puerta - Verrou

DIV-009 2FLG
Strike box - Gegenkasten - Cerradura
y Contra Cerradura - Contre serrure

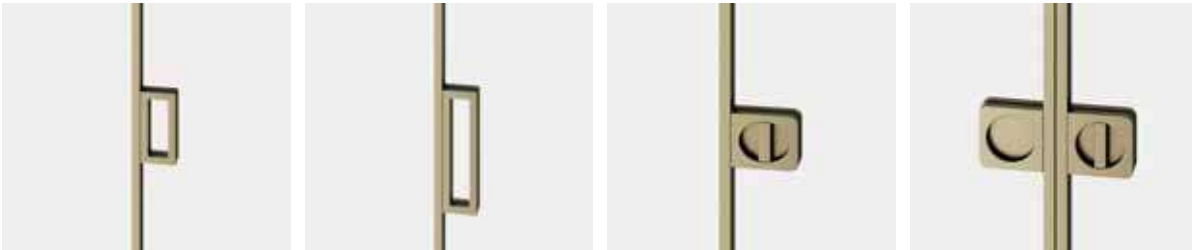

B-196

V-532-INC

POR-0408

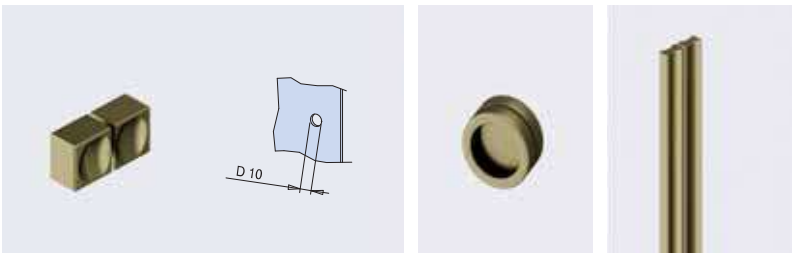

FINISHES - OBERFLÄCHEN - ACABADOS - FINITIONS

XO

BC

BS

AN

BI

NO



A system of frames and intermediate profiles to create an endless number of panels, all different from each other.

Ein System von Rahmenprofilen und Querleisten, um eine Vielzahl von Türen zu schaffen, die sich stets voneinander unterscheiden.

Un sistema de perfiles perimetrales y listones intermedios para crear una infinidad de puertas siempre diferentes entre sí.

Un système périphérique de profilés et de moulures intermédiaires pour créer une infinité de portes différentes.



SLIDING FRAMED DOOR





DIV
 PANEL - TÜR - PUERTA - PORTE

—
DIV-204
 CROSS PROFILE - QUERPROFIL - TRAVESAÑO - TRAVERSE

BC
 FINISHING - OBERFLÄCHE - ACABADO - FINITION

—
DIV-5600 Ri-EVOLUTION
 SYSTEM - SYSTEM - SISTEMA - SYSTEME

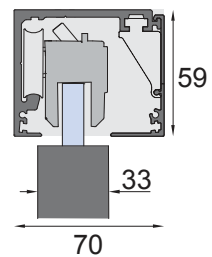

DIV
 PANEL - TÜR - PUERTA - PORTE

AN
 FINISHING - OBERFLÄCHE - ACABADO - FINITION

DIV-7600 Ri-EVOLUTION + V-7605
 INVISIBLE SYSTEM FOR SUSPENDED CEILING
 SYSTEM FÜR ABGEHÄNGTE DECKE SISTEMA INVISIBLE
 SISTEMA INVISIBLE EMPOTRADO EN EL TECHO
 SYSTEME INVISIBLE ENCASTRE DANS LE PLAFOND

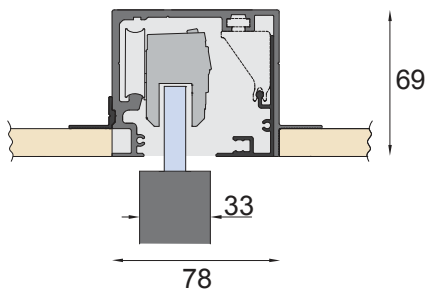



SLIDING DOORS

SLIDING FRAMED DOOR





DIV

PANEL - TÜR - PUERTA - PORTE

—

AN

FINISHING - OBERFLÄCHE - ACABADO - FINITION

—

DIV-5603 Ri-EVOLUTION

SYSTEM WITH FIXED PANEL
 SYSTEM MIT SEITENTEIL
 SISTEMA CON HOJA FIJA
 SYSTEME AVEC PANNEAU FIXE

