



INVISIBLE (OPTIONAL SOFT-CLOSE)

BINARI INVISIBILI / INVISIBLE TRACK PROFILES / UNSICHTBARE LAUFSCHIENEN



V-7600



 8-10	 8,76/10,76/12 12,76/13,52 con/with/mit V-5607	 500 min 1000 max
---	--	--



COMPONENTI / COMPONENTS / EINZELTEILE ▶ 130

V-7600

V-7602

120 Kg



V-5606-70 70 Kg | **V-5606-80** 80 Kg
V-5606-100 100 Kg | **V-5606-120** 120 Kg

V-012-INS

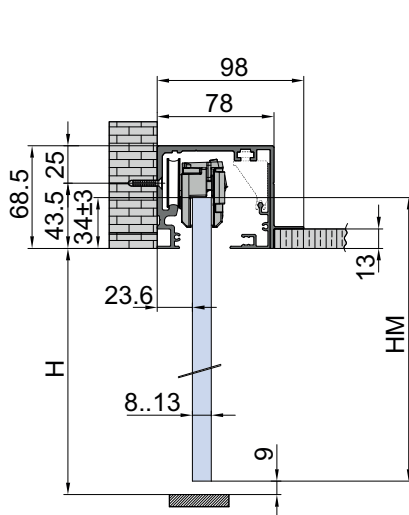
- Regolazione dal basso
- Adjustment from below
- Einstellung von unten

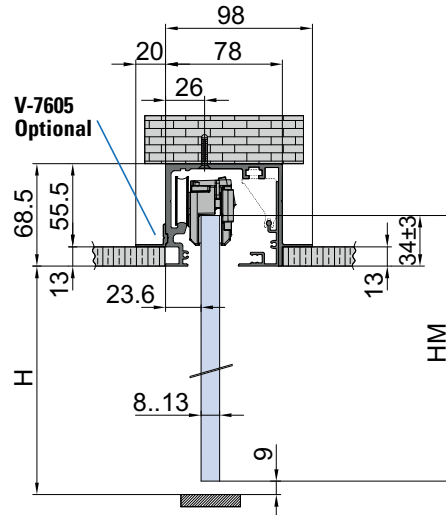

$$HM = H + 25$$



$$HM = H + 25$$



INVISIBLE

V-7600 SET 1

- Set per 1 anta scorrevole, fissaggio a parete/soffitto
- Sliding door set, wall/ceiling installation
- Schiebetürset 1-flügelig, Wand-Deckenmontage

€ ▶ S.100

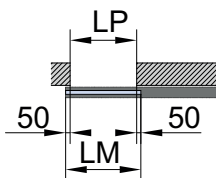
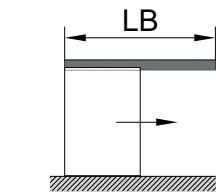

$$LB = LP \times 2 + 150$$

$$LM = LP + 100$$

V-7600 SET 2

- Set per 2 ante scorrevoli, fissaggio a parete/soffitto
- Sliding doors set, wall/ceiling installation
- Schiebetürset 2-flügelig, Wand-Deckenmontage

€ ▶ S.101

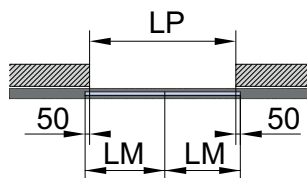
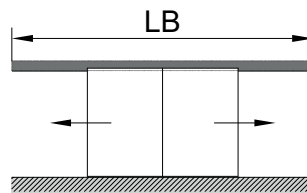

$$LB = LP \times 2 + 100$$

$$LM = (LP + 100) / 2$$

- Fori vetro sicurezza **optional**
- Security glass holes **optional**
- Sicherheitsbohrungen **optional**

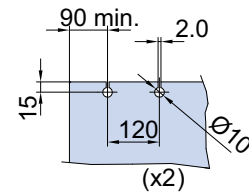

- **ATTENZIONE!** Per montaggio vetro in nicchia è necessaria preparazione spalle sfasate.
- **ATTENTION!** For glass installation in the niche, the walls must be prepared off line like drawing.
- **ACHTUNG!** Für die Glasmontage muss eine Wandseite gekürzt werden.

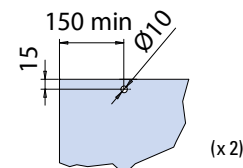

- Fori **optional** per V-5152
- Holes **optional** for V-5152
- Bohrungen **Optional** für V-5152

xme576f

Componenti / Components / Einzelteile ▶ 130	Fin. / Fin. / Oberf.	V-7600 SET 1	V-7600 SET 2
V-7600 L=2000 L=3000 L=4000 L=6000	AN	1	1
V-7605 L=2000 L=3000 L=4000 L=6000 (OPTIONAL)	GR	(1)	(1)
V-7602	-	1	2
V-5606-70 Kg / V-5606-80 Kg / V-5606-100 Kg / V-5606-120 Kg (OPTIONAL)	-	(1)	(2)
V-012-INS	AN	1	2

INVISIBLE (OPTIONAL SOFT-CLOSE)

BINARI INVISIBILI / INVISIBLE TRACK PROFILES / UNSICHTBARE LAUFSCHIENEN



V-7603



 8-10	 8,76/10,76/12 12,76/13,52 con/with/mit V-5607	 500 min 1000 max
----------	---	-------------------------



INVISIBLE

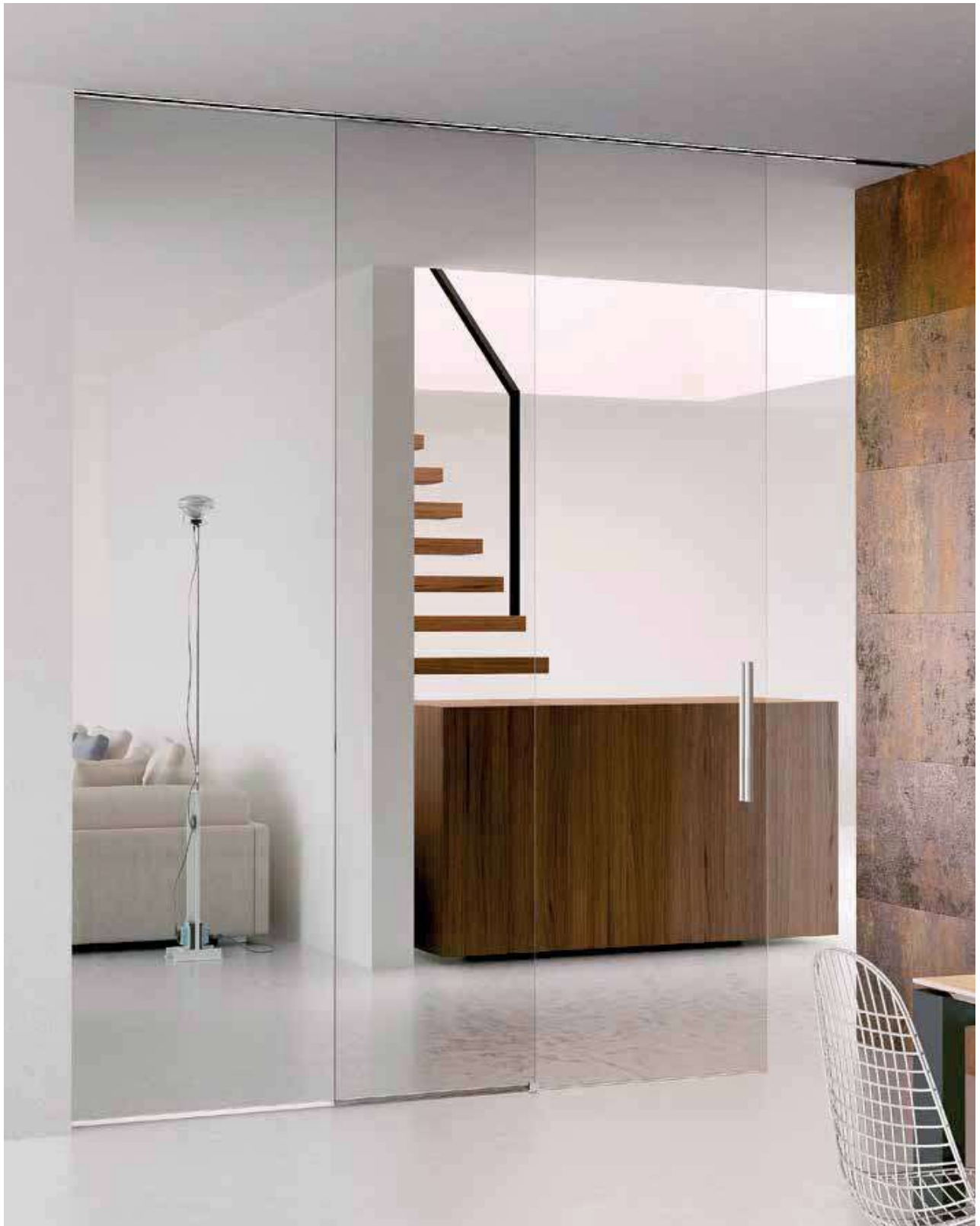

COMPONENTI / COMPONENTS / EINZELTEILE ▶ 130

V-7603

V-7602

120 Kg

V-5606-70 70 Kg | **V-5606-80** 80 Kg
V-5606-100 100 Kg | **V-5606-120** 120 Kg

V-012-INS

- Regolazione dal basso
- Adjustment from below
- Einstellung von unten

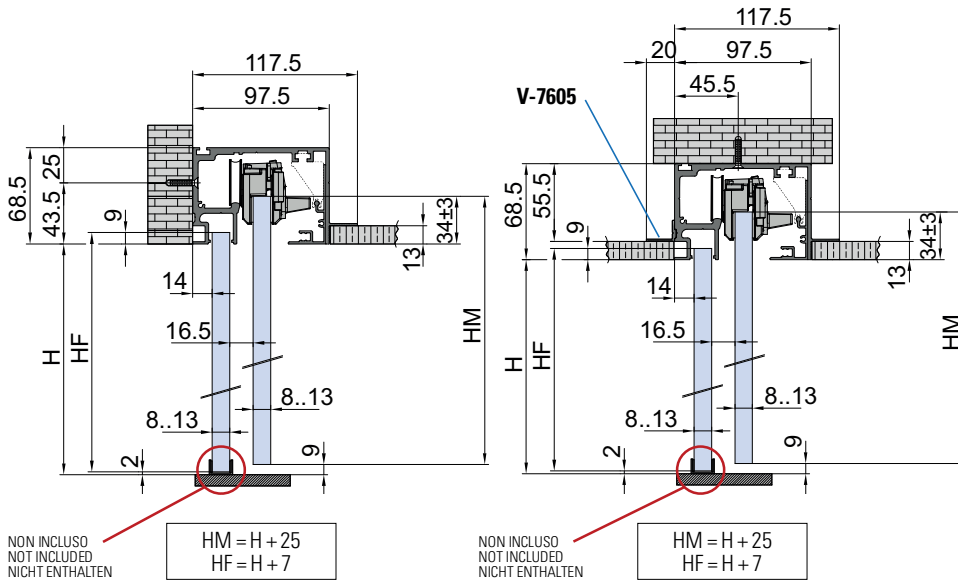

OPTIONAL	
VP-019-MT	VP-018-MT
2	3
1000 mm - 2000 mm - 3000 mm	
<ul style="list-style-type: none"> • Guarnizioni per sede vetro fisso • Gaskets for fixed glass • Dichtungen für Seitenteil 	
8	10
12	

INVISIBLE

V-7603 SET 1

- Set per 1 ante scorrevole e vetro fisso, fissaggio a parete/soffitto
- Sliding door set with fixed panel, wall/ceiling installation
- Schiebetürset 1-flügelig mit Seitenteil, Wand-Deckenmontage

€ ▶ S.102

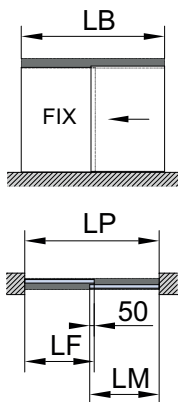

$$LB = LP \times 2 + 150$$

$$LM = LP + 100$$

V-7603 SET 2

- Set per 2 ante scorrevole e vetri fissi, fissaggio a parete/soffitto
- Sliding doors set with fixed panels, wall/ceiling installation
- Schiebetürset 2-flügelig mit Seitenteile, Wand-Deckenmontage

€ ▶ S.103

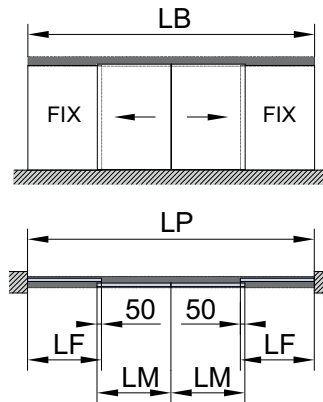

$$LB = LP \times 2 + 100$$

$$LM = (LP + 100) / 2$$

- Fori vetro sicurezza **optional**
- Security glass holes **optional**
- Sicherheitsbohrungen **optional**

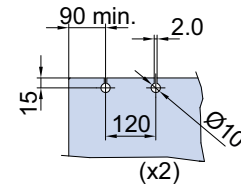

xme576g

Componenti / Components / Einzelteile ▶ 130	Fin. / Fin. / Oberf.	V-7603 SET 1	V-7603 SET 2
V-7603 L=2000 L=3000 L=4000 L=6000	AN	1	1
V-7605 L=2000 L=3000 L=4000 L=6000 (OPTIONAL)	GR	(1)	(1)
V-7602	-	1	2
V-5606-70 Kg / V-5606-80 Kg / V-5606-100 Kg / V-5606-120 Kg (OPTIONAL)	-	(1)	(2)
V-012-INS	AN	1	2



INVISIBLE (OPTIONAL SOFT-CLOSE)

BINARI INVISIBILI / INVISIBLE TRACK PROFILES / UNSICHTBARE LAUFSCHIENEN



V-7650



 8-10	 8,76/10,76/12 12,76/13,52 con/with/mit V-5607	 500 min 1000 max
---	--	--



INVISIBLE



COMPONENTI / COMPONENTS / EINZELTEILE ▶ 130

V-7650

V-7602

120 Kg

OPTIONAL
V-5606-70 70 Kg | **V-5606-80** 80 Kg
V-5606-100 100 Kg | **V-5606-120** 120 Kg

V-012-INS

- Regolazione dal basso
- Adjustment from below
- Einstellung von unten

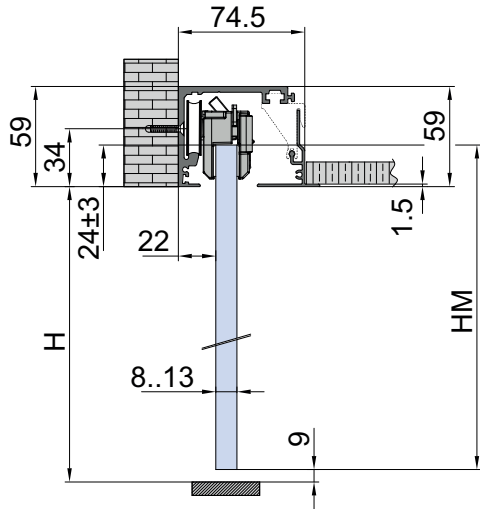

$$HM = H + 15$$



INVISIBLE

V-7650 SET 1

- Set per 1 anta scorrevole, fissaggio a parete/soffitto
- Sliding door set, wall/ceiling installation
- Schiebetürset 1-flügelig, Wand-Deckenmontage

€ ▶ S.98

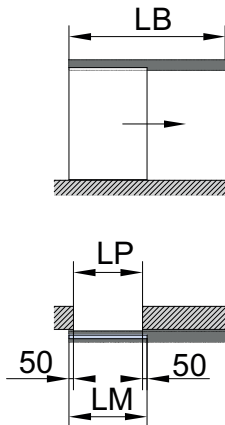

$$LB = LP \times 2 + 150$$

$$LM = LP + 100$$

V-7650 SET 2

- Set per 2 ante scorrevoli, fissaggio a parete/soffitto
- Sliding doors set, wall/ceiling installation
- Schiebetürset 2-flügelig, Wand-Deckenmontage

€ ▶ S.99

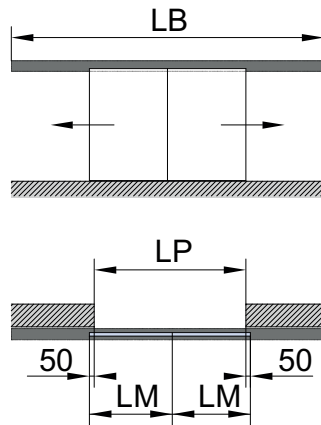

$$LB = LP \times 2 + 150$$

$$LM = (LP + 100) / 2$$

- Fori vetro sicurezza **optional**
- Security glass holes **optional**
- Sicherheitsbohrungen **optional**

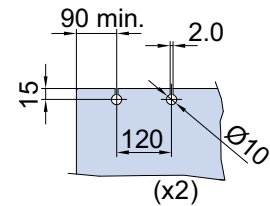

xme576e

Componenti / Components / Einzelteile ▶ 130	Fin. / Fin. / Oberf.	V-7600 SET 1	V-7600 SET 2
V-7650 L=2000 L=3000 L=4000 L=6000	AN	1	1
V-7602	-	1	2
V-5606-70 Kg / V-5606-80 Kg / V-5606-100 Kg / V-5606-120 Kg (OPTIONAL)	-	(1)	(2)
V-012-INS	AN	1	2

INVISIBLE (OPTIONAL SOFT-CLOSE)
BINARI INVISIBILI / INVISIBLE TRACK PROFILES / UNSICHTBARE LAUFSCHIENEN
COMPONENTI / COMPONENTS / EINZELTEILE



€ S.130



V-7600

- Guida di scorrimento completa di veletta
- Track profile with profile cover
- Führungsschiene mit Profilabdeckung

AN

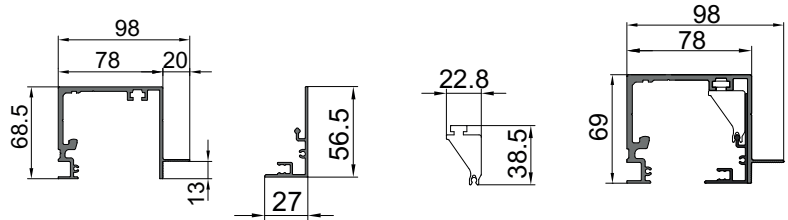

xme576f



INVISIBLE



V-7603

- Binario per anta scorrevole con vetro fisso laterale
- Track profile for sliding panel and fixed side panel
- Laufschiene für Schiebetür und Seitenteil

AN

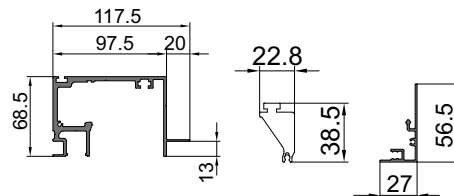

xme576g

€ S.131

OPTIONAL	
VP-019-MT	VP-018-MT
2	3
1000 mm - 2000 mm - 3000 mm	
<ul style="list-style-type: none"> • Guarnizioni per sede vetro fisso • Gaskets for fixed glass • Dichtungen für Seitenteil 	
8	10
10	12

€ S.297



V-7605

- Profilo per V-7600/V-7603 con appoggio per controsoffitto
- Profile for V-7600/V-7603 with support for suspended ceiling
- Profil für V-7600/V-7603 mit Auflage für Abgehängter Decke GR

€ S.138

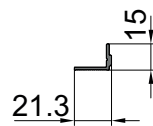

xme576g



V-7650

- Guida di scorrimento completa di veletta
- Track profile with profile cover
- Führungsschiene mit Profilabdeckung

AN

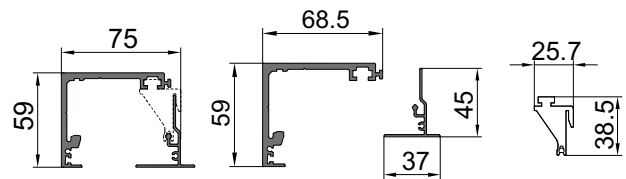

xme576e

€ S.106



V-7602

- Set accessori per 1 anta scorrevole composto da:
n° 2 carrelli, morsetti per vetro 8-10 mm,
n° 2 stoppers
- Accessories set for 1 sliding panel consisting of:
n° 2 roller carriers for 8/10 mm glass,
n° 2 stoppers
- Zubehör für 1 Schiebetür bestehend aus:
n° 2 Klemm - Laufwagen für 8/10 mm Glas,
n° 2 Stopper

120 Kg

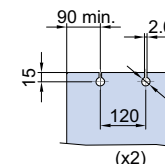
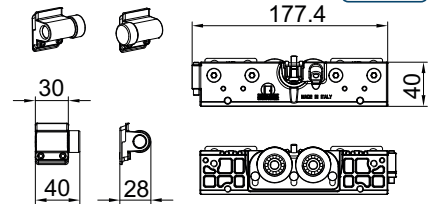

- Fori vetro sicurezza **optional**
- Security glass holes **optional**
- Sicherheitsbohrungen **optional**

xme576e

€ S.142

8-10	8,76/10,76/12,12,76/13,52 con/with/mit V-5607

- Regolazione dal basso
- Adjustment from below
- Einstellung von unten



soft-close
70 Kg

V-5606-70

- Set 2 stoppers Soft-close (per 1 anta)
- Set 2 stoppers Soft-close (for 1 sliding panel)
- Set 2 Stoppers Soft-close mit Selbsteinzug (für 1 Schiebetür)

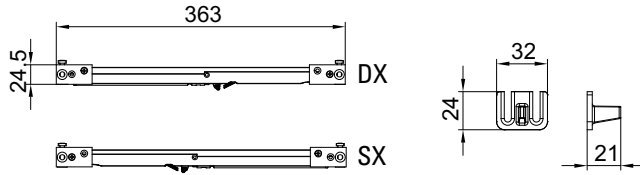

€ ▶ S.144

xme576d



soft-close
80 Kg

V-5606-80

- Set 2 stoppers Soft-close (per 1 anta)
- Set 2 stoppers Soft-close (for 1 sliding panel)
- Set 2 Stoppers Soft-close mit Selbsteinzug (für 1 Schiebetür)

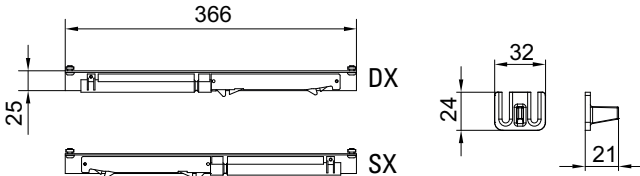

€ ▶ S.145

xme576d



100 Kg 120 Kg

V-5606-100 100 KG
V-5606-120 120 KG

- Set 2 stoppers Soft-close (per 1 anta)
- Set 2 stoppers Soft-close (for 1 sliding panel)
- Set 2 Stoppers Soft-close mit Selbsteinzug (für 1 Schiebetür)

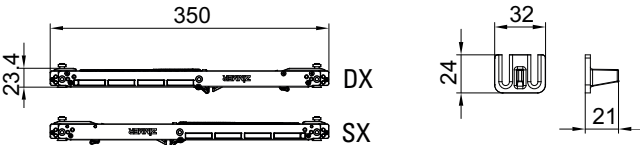

€ ▶ S.146

€ ▶ S.147

xme576d



V-5607

- Set per spessori vetro 8.76 - 10.76 - 12 - 12.76 - 13.5 (per 2 pinze V-5602/V-5652/V-7602)
- Set spacers for glass thickness 8.76 - 10.76 - 12 - 12.76 - 13.5 (for 2 clamps V-5602/V-5652/V-7602)
- Set Distanzscheiben für Glasdicke 8.76 - 10.76 - 12 - 12.76 - 13.5 (für 2 Klemm-Lauwagen V-5602/V-5652/V-7602)

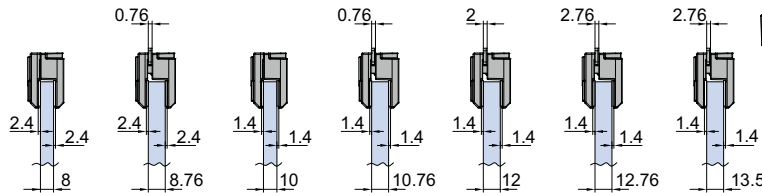
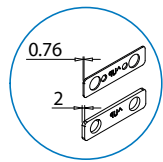

€ ▶ S.143

xme576i



V-012-INS

- Guida a pavimento regolabile per vetro da 8 a 13,5 mm con piastrina di fissaggio a terra per un facile inserimento della guida, ideale per scorrevoli invisibili e Telescopici
- Floor guide adjustable for glass from 8 to 13,5 mm. Perfect for invisible and Telescopic
- Bodenführung verstellbar für Glas von 8 bis 13,5mm perfekt für invisible und Teleskop Schiebe-Systeme, dank der Befestigungsplatte einsetzbar

AN - NS - CR

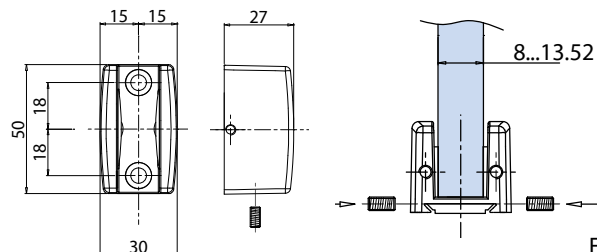
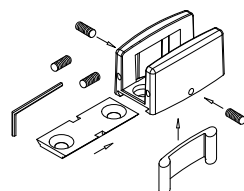

€ ▶ S.148

FB059-A

8-10-12
12.5-13-13.5

