

Ri-EVOLUTION (OPTIONAL SOFT-CLOSE)

BINARI A VISTA



V-5600

V-5650

V-5700



8-10	8,76/10,76/12 12,76/13,52 con V-5607	500 min 1000 max

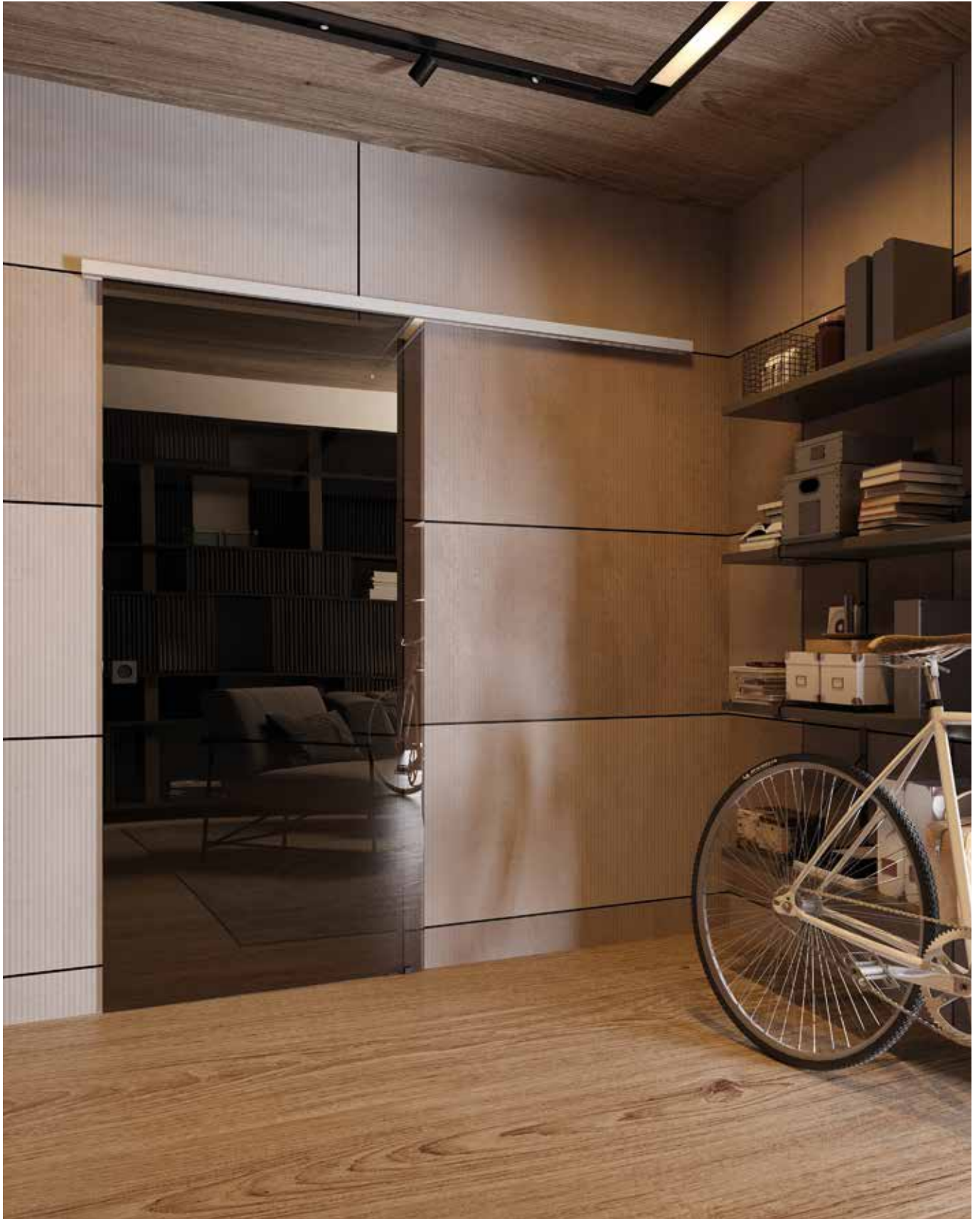

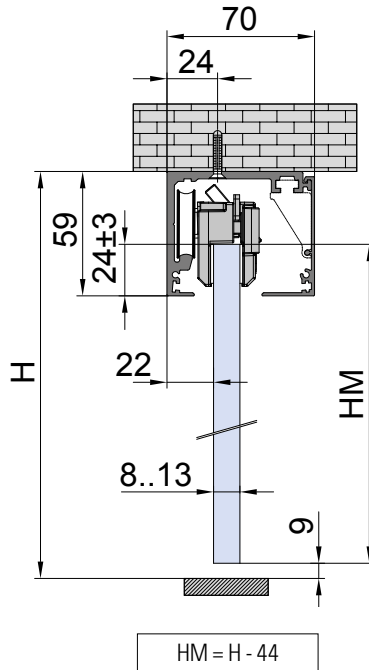
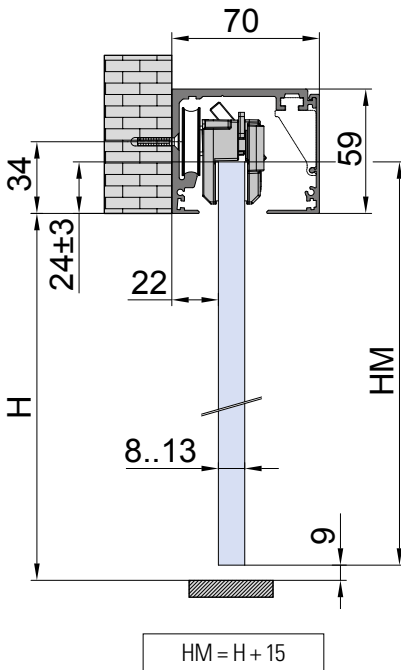
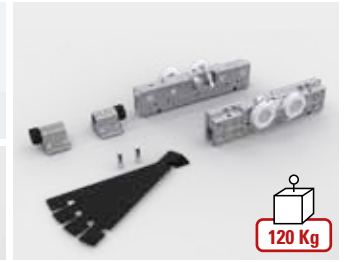
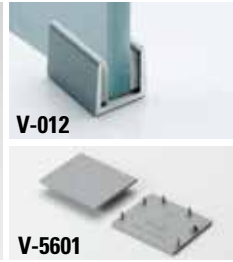
COMPONENTI ▶ 82

V-5602
• Regolazione frontale



V-5652
• Regolazione frontale



V-7602
• Regolazione dal basso

SIMPLE

V-5600 / V-5650 / V-5700 SET 1

• Set per 1 ante scorrevole, fissaggio a parete/soffitto

V-5600 / V-5650 / V-5700 SET 2

• Set per 2 ante scorrevoli, fissaggio a parete/soffitto

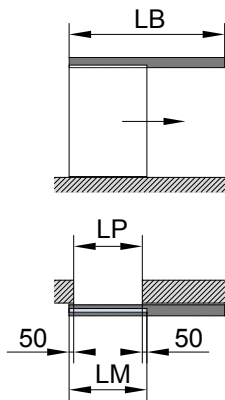

$$LB = LP \times 2 + 150$$

$$LM = LP + 100$$

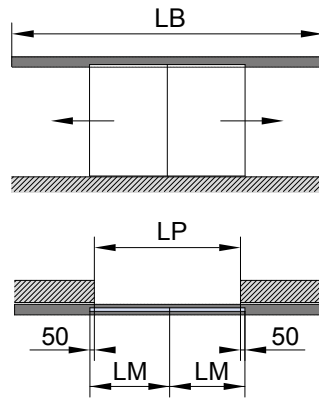

$$LB = LP \times 2 + 100$$

$$LM = (LP + 100) / 2$$

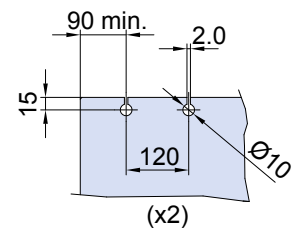
 • Fori vetro sicurezza **optional**

xme576a

Componenti ▶ 82	Fin.	V-5600 SET 1	V-5650 SET 1	V-5700 SET 1	V-5600 SET 2	V-5650 SET 2	V-5700 SET 2
V-5600 L=2000 L=3000 L=4000 L=6000	AN / NO / XO / BI / BC / BS	1	1	1	1	1	1
V-5602	-	1	-	-	2	-	-
V-5652	-	-	1	-	-	2	-
V-7602	-	-	-	1	-	-	2
V-5606-70 Kg / V-5606-80 Kg / V-5606-100 Kg / V-5606-120 Kg (OPTIONAL)	-	(1)	(1)	(1)	(2)	(2)	(2)
V-5601	AN / NO / XO / BI / BC / BS	1	1	1	1	1	1
V-012	AN / NO / NS	1	1	1	2	2	2

Ri-EVOLUTION (OPTIONAL SOFT-CLOSE)

BINARI A VISTA COMPONENTI



SIMPLE

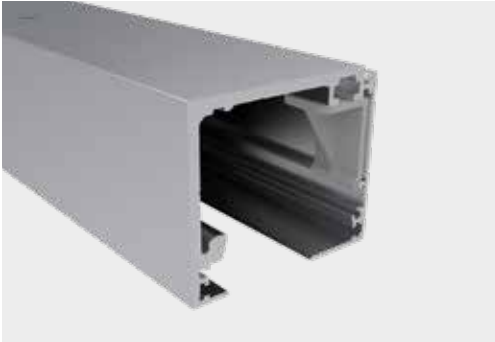

V-5600

- Guida di scorrimento completa di veletta AN-XO-NO-BI-BC-BS

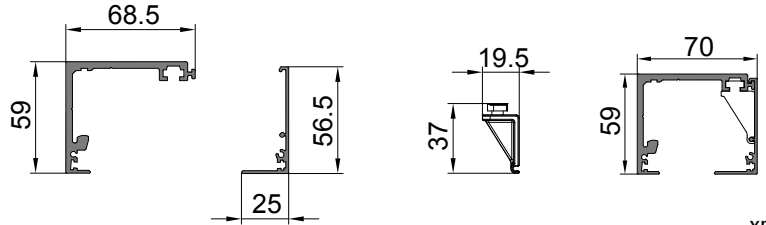

xme576d



V-5603

- Binario per anta scorrevole con vetro fisso laterale AN-XO-NO-BI-BC-BS

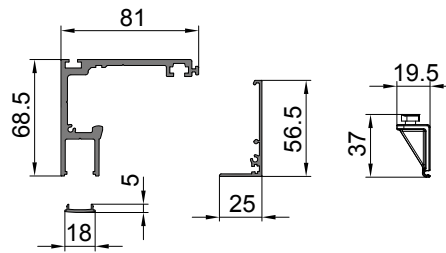

xme576d

OPTIONAL	
VP-019-MT	VP-018-MT
2	3
1000 mm - 2000 mm - 3000 mm	
• Guarnizioni per sede vetro fisso	
8	10
12	

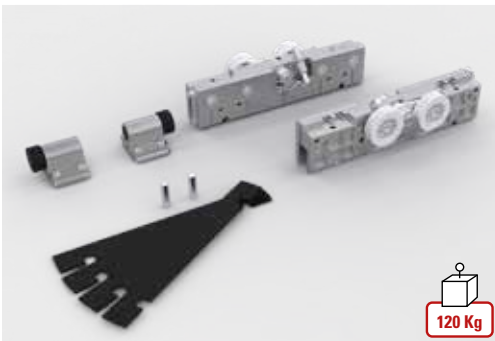

V-5602

- Set accessori per 1 anta scorrevole composto da:
n° 2 carrelli, morsetti per vetro 8-10 mm,
n° 2 stoppers

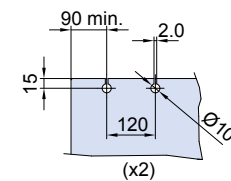
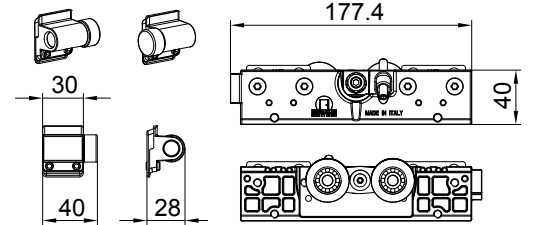

- Fori vetro sicurezza **optional**

xme576d

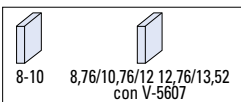

- Regolazione frontale

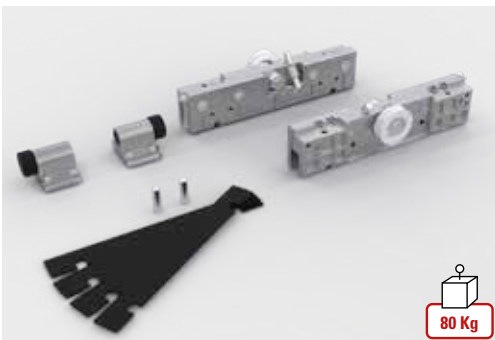

V-5652

- Set accessori per 1 anta scorrevole composto da:
n° 2 carrelli, morsetti per vetro 8-10 mm,
n° 2 stoppers

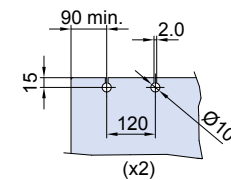
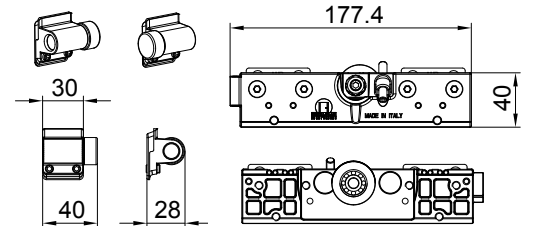

- Fori vetro sicurezza **optional**

xme576d

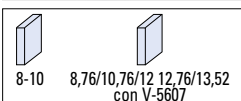

- Regolazione frontale



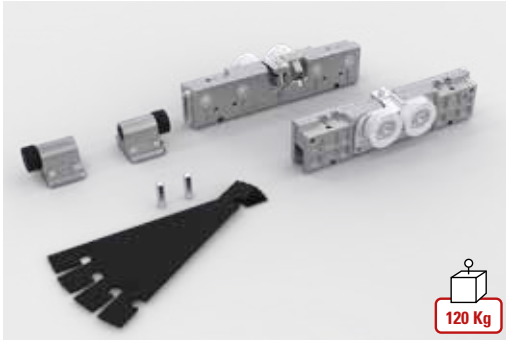

V-7602

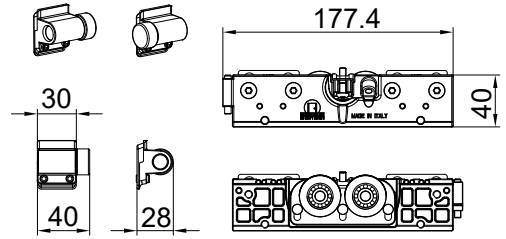
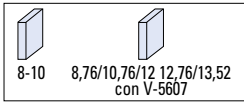
- Set accessori per 1 anta scorrevole composto da: n° 2 carrelli, morsetti per vetro 8-10 mm, n° 2 stoppers

120 Kg

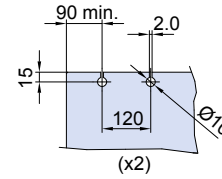
- Regolazione dal basso



- Fori vetro sicurezza **optional**

xme576e

SIMPLE

70 Kg
V-5606-70

- Set 2 stoppers Soft-close (per 1 anta)

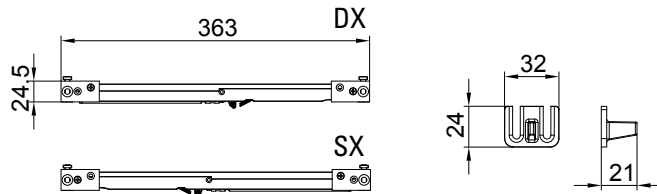

xme576d

80 Kg
V-5606-80

- Set 2 stoppers Soft-close (per 1 anta)
- Set 2 stoppers Soft-close (for 1 sliding panel)
- Set 2 Stoppers Soft-close mit Selbsteinzug (für 1 Schiebetür)

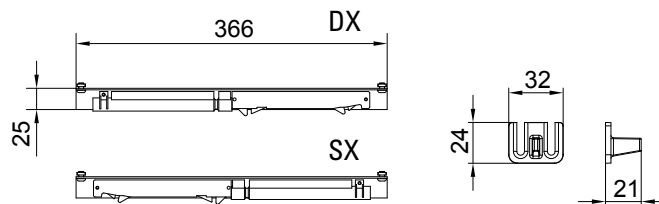

xme576d

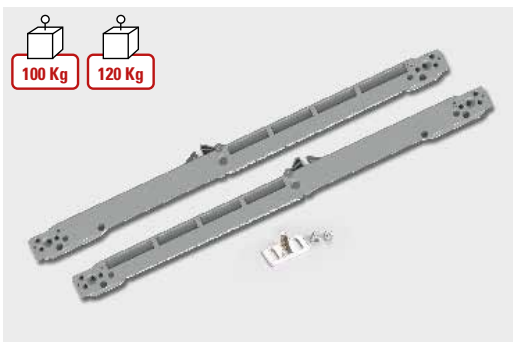
100 Kg **120 Kg**
V-5606-100 100 KG
V-5606-120 120 KG

- Set 2 stoppers Soft-close (per 1 anta)

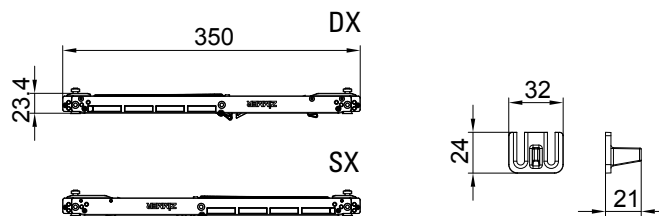

xme576d

Ri-EVOLUTION (OPTIONAL SOFT-CLOSE)

BINARI A VISTA

COMPONENTI



SIMPLE



V-5601
 • Paio tappi finali in plastica per guida a scorrimento V-5600
 AN-XO-NO-BI-BC-BS

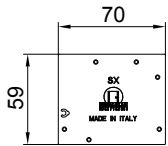

xme576d



V-5611
 • Paio tappi finali in alluminio per guida a scorrimento V-5603
 AN

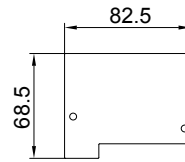

xme576d

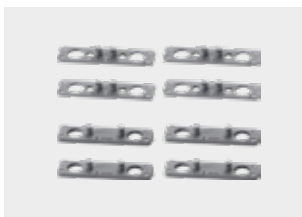

V-5607
 • Set per spessori vetro 8.76 - 10.76 - 12 - 12.76 - 13.5
 (per 2 pinze V-5602/V-5652/V-7602)

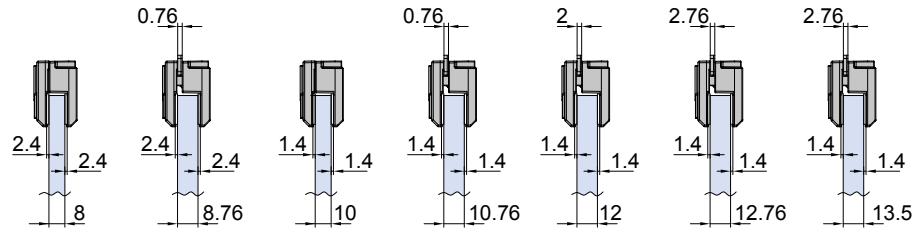
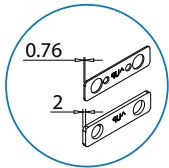
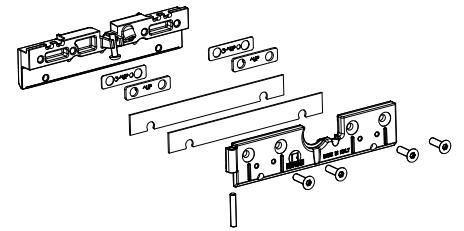

xme576i

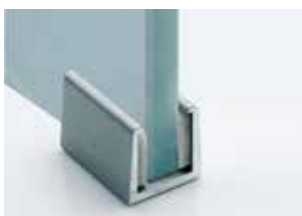

V-012
 • Guida a pavimento per scorrevole con feltrini per vetro 8 e 10 mm
 AN-NS

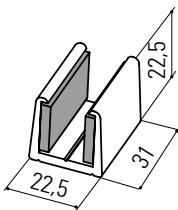

• Altri modelli disponibili a pag. 228



V-012-EVO
 • Guida a pavimento regolabile per vetro 8-10-12 mm
 AN-NS-NO-CR

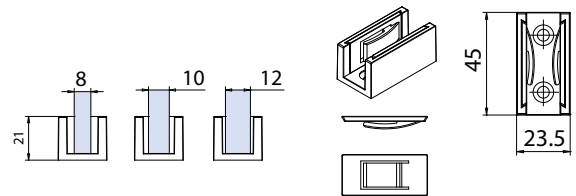

v-012new



V-012-REG
 • Guida a pavimento regolabile per vetro da 8 a 13,5 mm
 AN-NS-CR

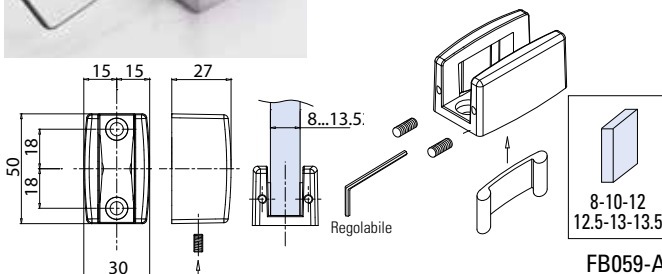

V-2014-MIX

• Canalina per vetro fisso escluso guarnizioni
 AN-IX

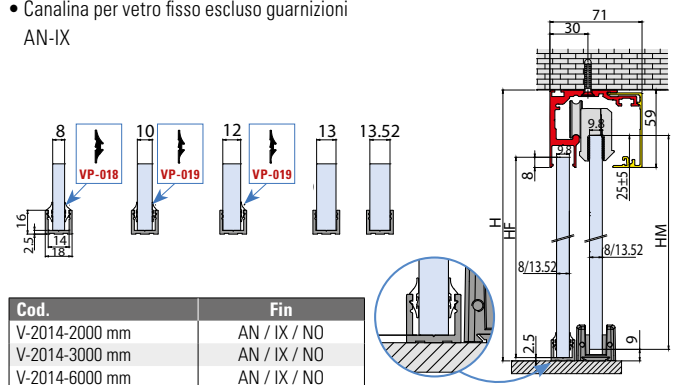

Cod.	Fin
V-2014-2000 mm	AN / IX / NO
V-2014-3000 mm	AN / IX / NO
V-2014-6000 mm	AN / IX / NO



V-5608

- Set staffe per fissaggio carrelli V-5602, V-5652 con pannello legno

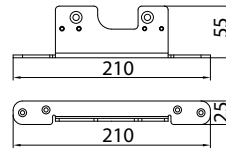
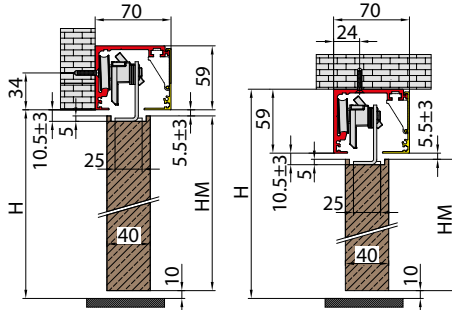
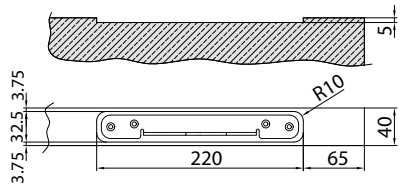

P-F08

- Guida a pavimento per ante in legno



SIMPLE

xme576o



V-6006

- Profilo e veletta per fissaggio binario a vetro (non preforato) AN-IX-NO

V-6007

- Paio di tappi laterali per profili fissaggio a vetro V-6006 AN-IX-NO

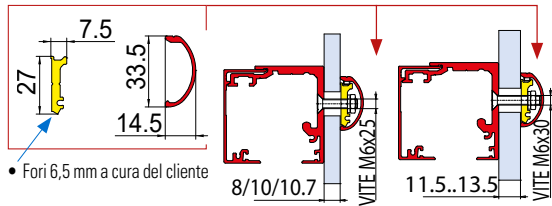
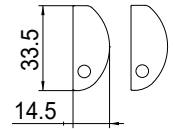

- Fori 6,5 mm a cura del cliente

Cod.	Fin.
V-6006-2000 mm	AN / XO / NO
V-6006-3000 mm	AN / XO / NO
V-6006-4000 mm	AN / XO / NO
V-6006-6000 mm	AN / XO / NO

xla340d

xla340d

V-5610

- Kit per apertura simultanea 2 ante compreso di 4 carrelli e stopper. Disponibile per sistemi Ri-EVOLUTION V-5600, V-5603.

sincro

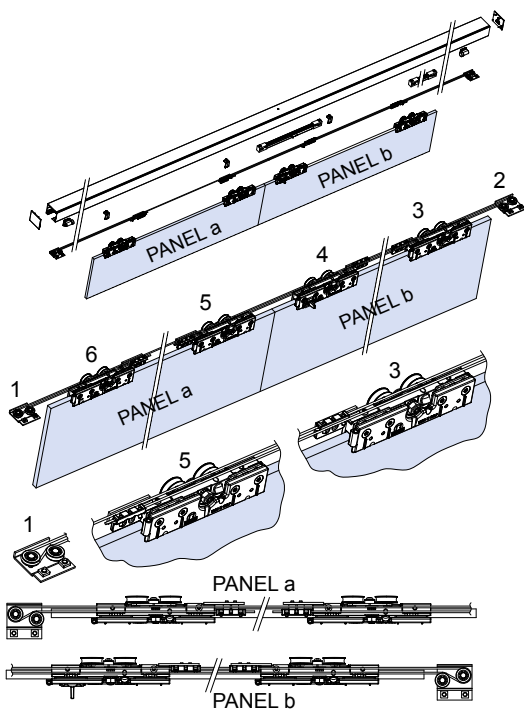
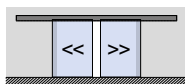

xme576n

V-5612

- N° 1 Staffa evolution autoportante reversibile DX-SX per fissaggio laterale binario V-5403/muro
- 1 pcs bracket for side fixing evolution profile V-5403
- 1 Stück winklprofil für Seitliche Wandbefestigung Evolution Laufschiene V-5403

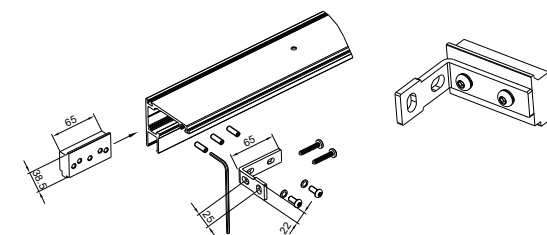
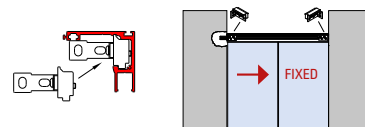
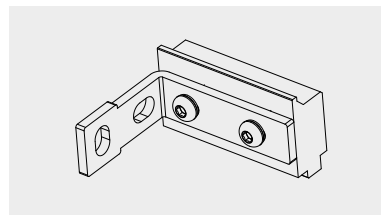

xme576q