

DEA (OPTIONAL SOFT-CLOSE)
BINARI A VISTA / VISIBLE TRACK PROFILES / SICHTBARE LAUFSCHIENEN



V-1900 / V-1910 / V-1920



8-10	8,76/10,76/12 12,76/13,52 con/with/mit V-1817	550 min 1000 max



SIMPLE

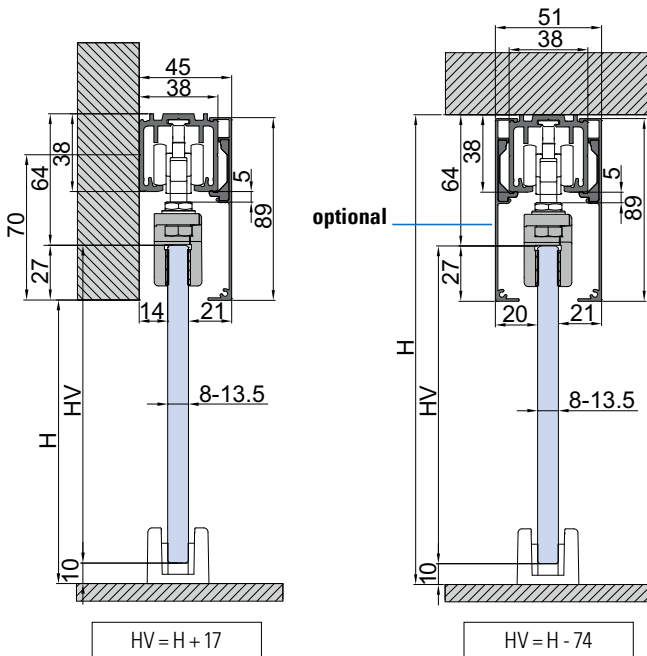

COMPONENTI / COMPONENTS / EINZELTEILE ▶ 100

- Fori vetro sicurezza **optional**
- Security glass holes **optional**
- Sicherheitsbohrungen **optional**

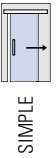
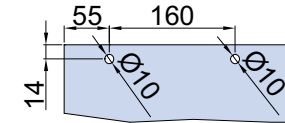
V-1906-D70 SOFT-CLOSE

	Soft-close chiusura / apertura double acting doppelt Wirkende	Fori optional Optional holes Bohrungen optional
--	--	---

min 700	1	-
---------	---	---

min 790	1	✓
---------	---	---

V-1906-D100 SOFT-CLOSE

	Soft-close chiusura / apertura double acting doppelt Wirkende	Fori optional Optional holes Bohrungen optional
--	--	---

min 700	1	-
---------	---	---

min 790	1	✓
---------	---	---

V-1906-70 SOFT-CLOSE

	Soft-close solo chiusura single acting einzeln Wirkende	Fori optional Optional holes Bohrungen optional
--	--	---

min 660	1	-
---------	---	---

min 750	1	✓
---------	---	---

V-1900 / V-1910 / V-1920 SET 1

- Set per 1 anta scorrevole, fissaggio a parete/soffitto
- Sliding door set, wall/ceiling installation
- Schiebetürset 1-flügelig, Wand-Deckenmontage

€▶ S.161 €▶ S.161.1 €▶ S.161.2

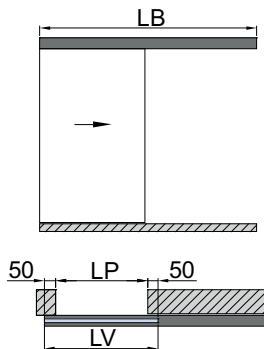

$$LB = LP \times 2 + 150$$

$$LV = LP + 100$$

V-1900 / V-1910 / V-1920 SET 2

- Set per 2 ante scorrevoli, fissaggio a parete/soffitto
- Sliding doors set, wall/ceiling installation
- Schiebetürset 2-flügelig, Wand-Deckenmontage

€▶ S.162 €▶ S.162.1 €▶ S.162.2

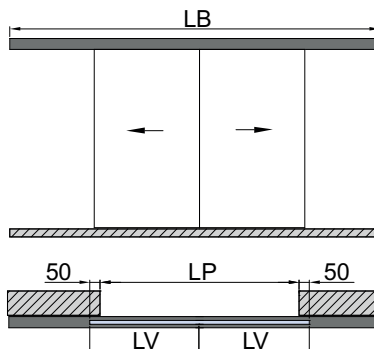

$$LB = LP \times 2 + 100$$

$$LV = (LP + 100) / 2$$

xme600g

Componenti / Components / Einzelteile ▶ 100	Fin. / Fin. / Oberf.	V-1900 SET 1	V-1910 SET 1	V-1920 SET 1	V-1900 SET 2	V-1910 SET 2	V-1920 SET 2
V-1900 L=2000 L=3000 L=4000 L=6000	AN	1	1	1	1	1	1
V-1901 L=2000 L=3000 L=4000 L=6000	AN / NO / IXO	1	1	1	1	1	1
V-1902 senza / without Soft-close	-	1	-	-	2	-	-
V-1912 con / with Soft-close solo in chiusura / single acting 70 Kg	-	-	1	-	-	2	-
V-1922 con / with Soft-close doppio / double acting 100 Kg	-	-	-	1	-	-	2
V-1908	AN / NO / IXO	1	1	1	1	1	1
V-012	AN / NO / NS	1	1	1	2	2	2

DEA / FUSION (OPTIONAL SOFT-CLOSE)
COMPONENTI / COMPONENTS / EINZELTEILE



SIMPLE



- V-1900**
- Binario Scorrevole
 - Track profile
 - Laufschienenprofil
- AN-NO

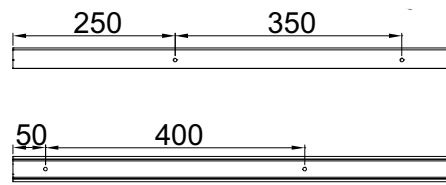
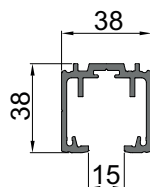

€ S.165

xme600i



- V-1901**
- Voletta per binario
 - Cover profile for track profile
 - Profilabdeckung für Laufschienenprofil
- AN-IXO-NO

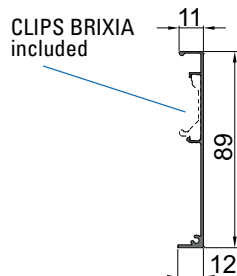

€ S.167

xme600i



- V-1904**
- Profilo per vetro fisso
 - Side panel profile
 - Seitenteilprofil
- AN-IXO-NO

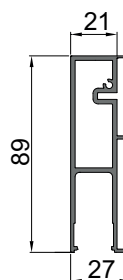

€ S.171

xme600i

OPTIONAL	
VP-019-MT	VP-018-MT
1000 mm - 2000 mm - 3000 mm	
<ul style="list-style-type: none"> • Guarnizioni per sede vetro fisso • Gaskets for fixed glass • Dichtungen für Seitenteil 	

€ A.138



- V-1927**
- Profilo a muro per binario V-1900 con anta FUSION
 - Wall profile for V-1900 track profile with panel FUSION
 - Wandprofil für V-1900 Laufschiene mit Flügel FUSION
- AN-IXO-NO-BI-BC-BS

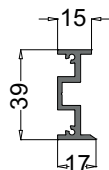

€ S.269

xme596

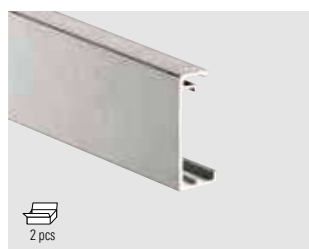

- V-1929-CF2**
- Voletta per binario V-1900 con anta FUSION
 - Cover profile for track profile V-1900 with panel FUSION
 - Abdeckung für Laufschienenprofil V-1900 mit Flügel FUSION
- AN-IXO-NO-BI-BC-BS

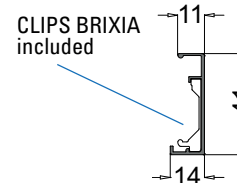

€ S.271

xme596



- V-1950**
- Profilo cassamatta per binario V-1900 invisibile
 - Concealed substructure for track profile V-1900
 - Profilträger, versenkte Montage für Laufschiene V-1900
- GR

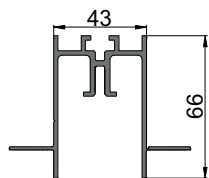

€ S.278

xme596b



- V-1955**
- Profilo cassamatta doppio per binario V-1900 invisibile
 - 2-ways concealed substructure for track profile V-1900
 - Profilträger 2-Wege, versenkte Montage für Laufschiene V-1900
- GR

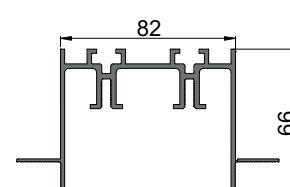

€ S.280

xme596b



V-1902

€▶ S.177

- Set accessori per 1 anta scorrevole composto da 2 carrelli, morsetti per vetro 8-10 mm. 2 stoppers
Kit senza soft-close
- Accessories set for 1 sliding panel consisting of N°2 trolley hangers with clamp carriage for 8/10 mm glass, N°2 endstops. **Kit without soft-close**
- Zubehör für 1 Schiebetür bestehend aus: N°2 Klemm - Laufwagen für 8/10 mm Glas. N°2 Stopper
Kit ohne soft-close

100 Kg

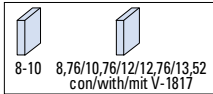
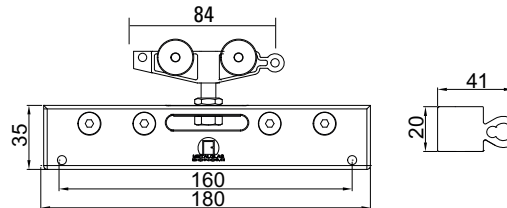

xme600i

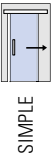

V-1912

€▶ S.178

- Set accessori per 1 anta scorrevole composto da 2 carrelli, morsetti per vetro 8-10 mm. 2 stoppers.
Kit con soft-close in chiusura
- Accessories set for 1 sliding panel consisting of N°2 trolley hangers with clamp carriage for 8/10 mm glass, N°2 endstops. **Kit with soft-close single acting**
- Zubehör für 1 Schiebetür bestehend aus: N°2 Klemm - Laufwagen für 8/10 mm Glas. N°2 Stopper.
Kit mit Soft-Close-einzeln Wirkende

100 Kg

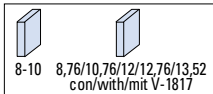
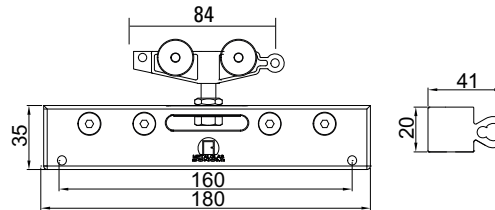

solo chiusura/
single acting/
nur Schließung
con/with/mit soft-close 70 Kg

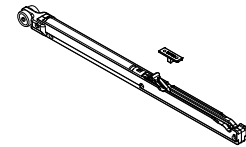

xme600i/xme600i



V-1922

€▶ S.179

- Set accessori per 1 anta scorrevole composto da 2 carrelli, morsetti per vetro 8-10 mm. 2 stoppers.
Kit con soft-close doppio
- Accessories set for 1 sliding panel consisting of N°2 trolley hangers with clamp carriage for 8/10 mm glass, N°2 endstops. **Kit with soft-close double acting**
- Zubehör für 1 Schiebetür bestehend aus: N°2 Klemm - Laufwagen für 8/10 mm Glas. N°2 Stopper.
Kit mit Soft-Close-doppelt Wirkende

100 Kg

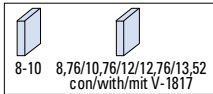
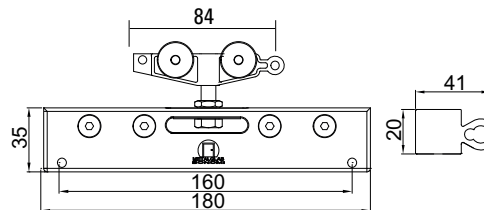

chiusura/
closing/Schließung
apertura/
opening/Öffnen
con/with/mit soft-close 100 Kg

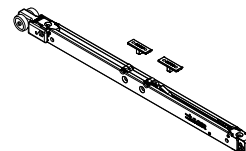

xme600i/xme600i

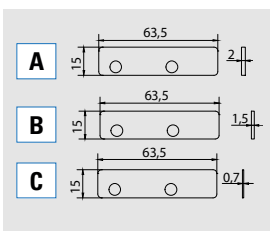

V-1817-A

V-1817-B

V-1817-C

- Kit spessori per vetro 12 - 12,7 - 13,5 per 2 pinze V-090 e V-090-T
- Kit spacers for glass thickness 12 - 12,7 - 13,5 for 2 clamps V-090 and V-090-T
- Kit Distanzscheiben für Glasdicke 12 - 12,7 - 13,5 für 2 Klemm-Laufwagen V-090 und V-090-T

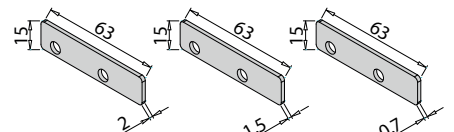

xme425t

€▶ A.180



V-012

€▶ A.184

- Guida a pavimento per scorrevole con feltrini per vetro 8 e 10 mm
- Floor guide with felt strips for glass sliding door a 8 and 10 mm
- Bodenführung mit Filzleiter für Glas 8 und 10 mm AN-NS

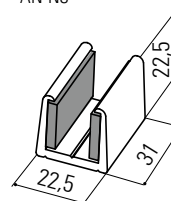

- Altri modelli disponibili a pag. 228
- Other models available on page. 228
- Weitere Modelle auf Seite 228

DEA / FUSION (OPTIONAL SOFT-CLOSE)

COMPONENTI / COMPONENTS / EINZELTEILE



SIMPLE

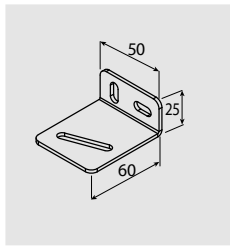

V-1867 € S.183

- Staffa per fissaggio a parete per sistema V-1903 (circa 1 pezzo ogni 400 mm)
- Bracket for wall installation for system V-1903 (about 1 piece every 400 mm)
- Winkelverbinder für Wandmontage System V-1903 (1 Stück je ca 400 mm)

xme600i

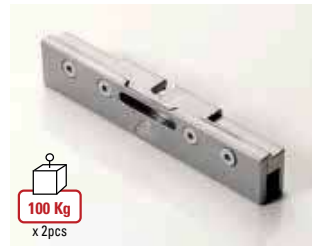

V-090

- Pinza
- Clamp
- Klemmschuh

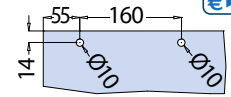

- Fori optional
- Holes optional
- Bohrungen Optional

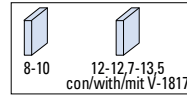
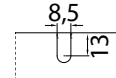
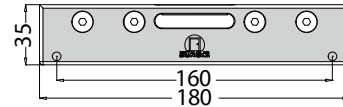

€ S.185

xme600i



V-1816

- Carrello
- Carrier
- Laufwagen

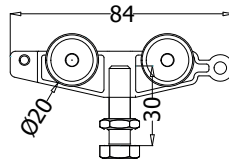

€ S.187

xme600i



V-1817

- Stoppers

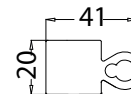

€ S.188

xme600i

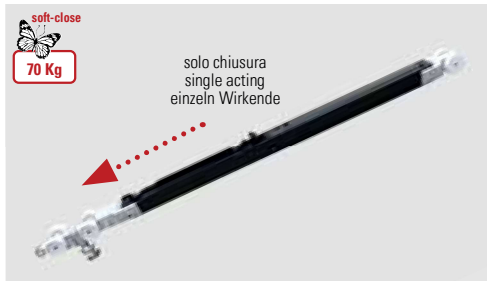

V-1900 / V-1903

	Soft-close	Fori optional Optional holes Bohrungen optional
min 660	1	-
min 750	1	✓

FUSION

	Soft-close	Fori optional Optional holes Bohrungen optional
min 670	1	-
min 730	1	✓

V-1906-70 - 70 Kg

- Soft-close per sistemi V-1900 / V-1903 / FUSION
- Soft-close mechanism for systems V-1900 / V-1903 / FUSION
- Soft-close für Systeme V-1900 / V-1903 / FUSION

€ S.180

xme600i/xme596a

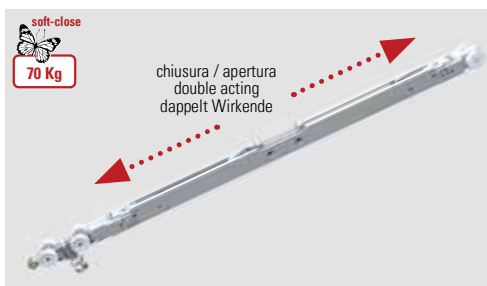
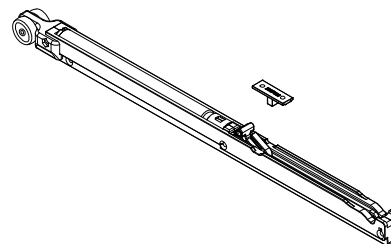

V-1900 / V-1903

	Soft-close	Fori optional Optional holes Bohrungen optional
min 700	1	-
min 790	1	✓

FUSION

	Soft-close	Fori optional Optional holes Bohrungen optional
min 720	1	-
min 780	1	✓

V-1906-D70 - 70 Kg

V-1906-D100 - 100 Kg

- Soft-close per sistemi V-1900 / V-1903 / FUSION
- Soft-close mechanism for systems V-1900 / V-1903 / FUSION
- Soft-close für Systeme V-1900 / V-1903 / FUSION

€ S.181 € S.182

xme600i/xme596a

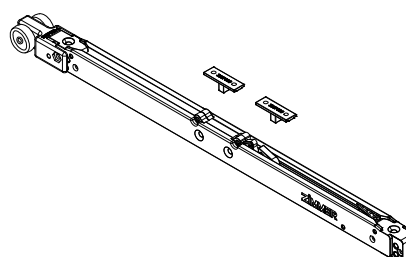

V-1908

- Paio tappi finali per binario V-1900
- Pair endcaps for track profile V-1900
- Paar Endkappe für Laufschienenprofil V-1900 AN-IXO-NO

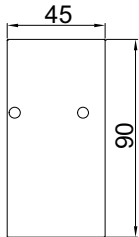

€ ▶ S.175

xme600i

V-1905

- Paio tappi finali per sistema V-1903
- Pair endcaps for system V-1903
- Paar Endkappe für System V-1903 AN

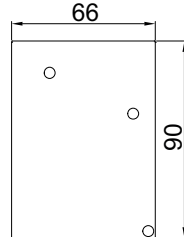

€ ▶ S.176

xme600i

FUS-1908

- Paio tappi finali per sistema FUSION a parete
- Pair endcaps for system FUSION, wall installation
- Paar Endkappe für System FUSION, Wandmontage AN-IXO-NO-BI-BC-BS

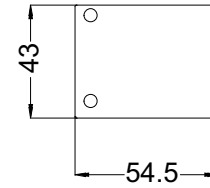

€ ▶ S.274

xme600i

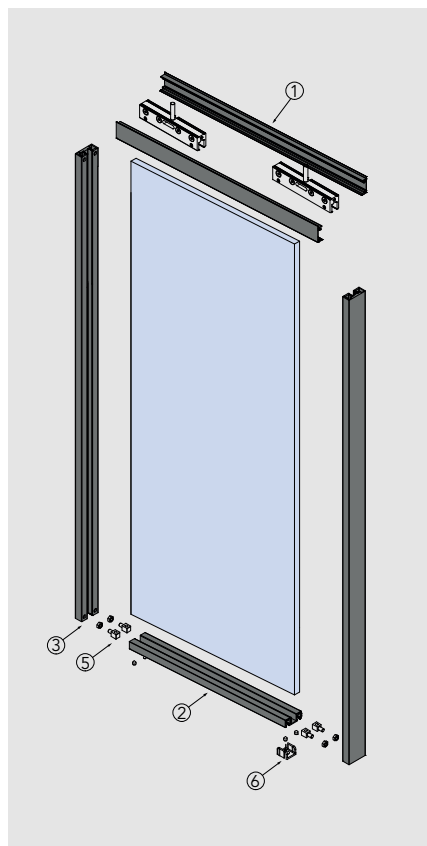
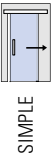
SET ANTA / PANEL SET
FUS-995 995 x 2980 mm
FUS-1495 1495 x 2980 mm

€ ▶ S.240

1 FUS-104 € ▶ S.257

- FUS-104 kit superiore con 2 pinze V-104 e 2 alette di copertura
- Kit with 2 top clamps V-104 and 2 cover profiles
- Kit mit 2 Klemmschuhe V-104 und 2 Abdeckungen

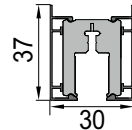
2 DIV-203 € ▶ S.255

- Traverso inferiore
- Horizontal bottom profile
- Unterer Horizontalprofil

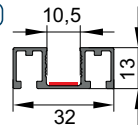
3 DIV-202 € ▶ S.253

- Montante verticale
- Vertical profile
- Vertikalprofil

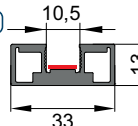
4 DIV-204 € ▶ S.243

- Traversino
- Cross profile
- Querprofil

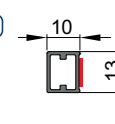
5 P-F38 € ▶ S.262

- Kit assemblaggio
- Assembly kit
- Montage-Kit

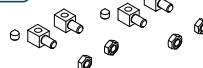
6 DIV-012 € ▶ S.263

- Guida porta
- Door guide
- Bodenführung

7 DIV-01 € ▶ S.265

- Dima foratura
- Drilling template
- Bohrschablone

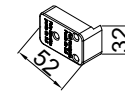
FUS-TS12 € ▶ S.264

- Guida a pavimento per anta FUSION con controtelaio a scomparsa
- Floor guide for FUSION panel with pocket system
- Bodenführung für FUSION Tür mit kastensystem

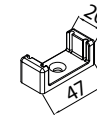

- Biadesivo preinstallato
- Pre-installed double-side adhesive
- Selbstklebend

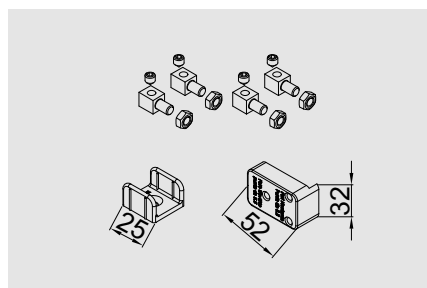
FUS-KIT

€ ▶ S.261

- Kit assemblaggio 1 anta FUSION composto da guida, dima e squadrette
- Fixing materials and floor guide to assembly 1 framed panel FUSION
- Befestigungsmaterial und Bodenführung für 1 set Flügelrahmen FUSION