

ESSENZA

SLIDING COLLECTION

ESSENZA literally indicates the characteristics of an object which constitute its essence.

ESSENZA is the latest of these collections but represents the beginning of everything, the base on which Frames, Filo and Fusion are built, as well as the beginning of the history of Metalglas.

ESSENZA bezieht sich auf jene Bestimmtheit einer Sache, die ihre Natur ausmacht. ESSENZA ist die neueste dieser Kollektionen, stellt jedoch den Anfang von allem dar, die Grundlage, auf der Frames, Filo und Fusion aufbauen, sowie den Beginn der Geschichte von Metalglas.

Literalmente ESSENZA indica aquellas determinaciones de una cosa, que constituyen su naturaleza. ESSENZA es la última de estas colecciones, pero representa el comienzo de todo, la base sobre la que se construyen Frames, Filo y Fusión, así como el comienzo de la historia de Metalglas

Littéralement, l'ESSENCE indique les déterminations d'une chose, qui constituent sa nature. ESSENCE est la dernière de ces collections, mais elle représente le début de tout, la base sur laquelle sont construites Frames, Filo et Fusion et le début de l'histoire de Metalglas.





NO
FINISHING - OBERFLÄCHE - ACABADO - FINITION

V-5600 Ri-EVOLUTION
SYSTEM WITH FRAMELESS DOOR
SYSTEM MIT GANZGLASTÜR
SISTEMA CON PUERTA TODO VIDRIO
SYSTEME AVEC PORTE TOUT VERRE

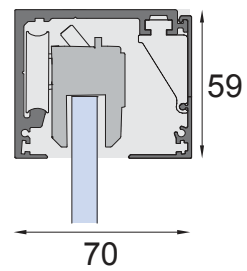



AN
FINISHING - OBERFLÄCHE - ACABADO - FINITION

V-5600 Ri-EVOLUTION
SYSTEM WITH FRAMELESS DOOR
SYSTEM MIT GANZGLASTÜR
SISTEMA CON PUERTA TODO VIDRIO
SYSTEME AVEC PORTE TOUT VERRE

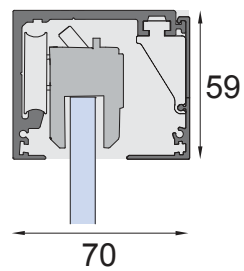



AN
FINISHING - OBERFLÄCHE - ACABADO
- FINITION



V-7600 Ri-EVOLUTION + V-7605
INVISIBLE SYSTEM FOR SUSPENDED CEILING
WITH FRAMELESS DOOR
SYSTEM FÜR ABGEHÄNGTE DECKE
MIT GANZGLASTÜR
SISTEMA INVISIBLE EMPOTRADO
EN EL TECHO CON PUERTA TODO VIDRIO
SYSTEME INVISIBLE ENCASTRES
DANS LE PLAFOND AVEC PORTE TOUT VERRE

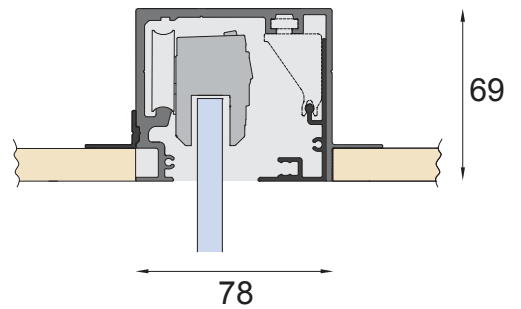



AN

FINISHING - OBERFLÄCHE - ACABADO - FINITION

V-5520 FIFTY

SYSTEM WITH FRAMELESS DOOR

SYSTEM MIT GANZGLASTÜR

SISTEMA CON PUERTA TODO VIDRIO

SYSTEME AVEC PORTE TOUT VERRE

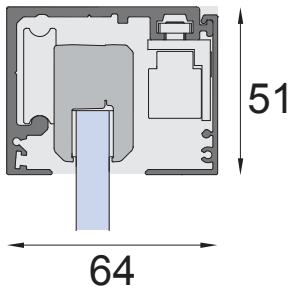

SLIDING FRAMED DOOR





AN

FINISHING - OBERFLÄCHE - ACABADO - FINITION

V-7600 Ri-EVOLUTION

INVISIBLE SYSTEM FOR SUSPENDED

CEILING WITH FRAMELESS DOOR

SYSTEM FÜR ABGEHÄNGTE DECKE

MIT GANZGLASTÜR

SISTEMA INVISIBLE EMPOTRADO EN EL TECHO

CON PUERTA TODO VIDRIO

SYSTEME INVISIBLE ENCASTRE DANS LE PLAFOND

AVEC PORTE TOUT VERRE

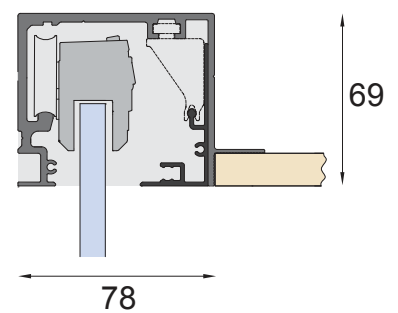



AN
FINISHING - OBERFLÄCHE - ACABADO - FINITION

V-5603 Ri-EVOLUTION
SYSTEM WITH FRAMELESS DOOR AND FIXED
SIDE PANEL
SYSTEM MIT GANZGLASTÜR UND SEITENTEIL
SISTEMA CON PUERTA TODO VIDRIO Y VIDRIO FIJO
SYSTEME AVEC PORTE TOUT VERRE PLUS FIXE

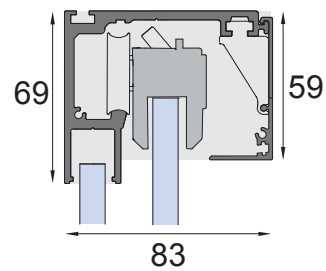



SLIDING DOORS

AN
FINISHING - OBERFLÄCHE - ACABADO
- FINITION

V-7603 Ri-EVOLUTION + V-7605
INVISIBLE SYSTEM FOR SUSPENDED CEILING
WITH FRAMELESS DOOR AND FIXED SIDE PANEL
SYSTEM FÜR ABGEHÄNGTE DECKE
MIT GANZGLASTÜR UND SEITENTEIL
SISTEMA INVISIBLE EMPOTRADO
EN EL TECHO CON PUERTA TODO VIDRIO Y VIDRIO FIJO
SYSTEME INVISIBLE ENCASTRE
DANS LE PLAFOND AVEC PORTE TOUT VERRE PLUS FIXE

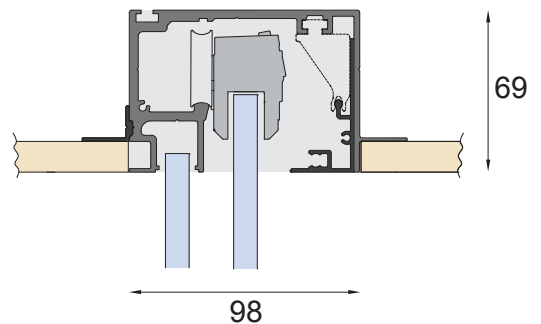





SLIDING DOORS

AN
FINISHING - OBERFLÄCHE - ACABADO - FINITION

V-1900 DEA
SYSTEM WITH FRAMELESS DOOR
SYSTEM MIT GANZGLASTÜR
SISTEMA CON PUERTA TODO VIDRIO
SYSTEME AVEC PORTE TOUT VERRE

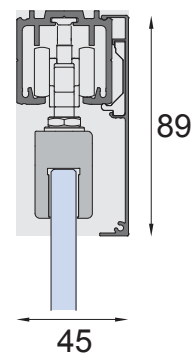

ESSENZA - Ri-EVOLUTION

VISIBLE TRACK PROFILES - SICHTBARE LAUFSCHIENEN - RIELES A LA VISTA - RAILS VISIBLES

1-WAY TRACK PROFILE
1-WEG-LAUFSCHIENE
RIEL DE 1 CARRIL
RAIL 1-VOIE

CEILING INSTALLATION
DECKENMONTAGE
A TECHO
PLAFOND

WALL INSTALLATION
WANDMONTAGE
A PARED
MUR



V-5600 / V-5650 / V-5700

Technical pages - Technische Seiten - Páginas Técnicas - Pages Techniques ► 178

ceiling
Decke / a techo / plafond

wall
Wand / a pared / mur

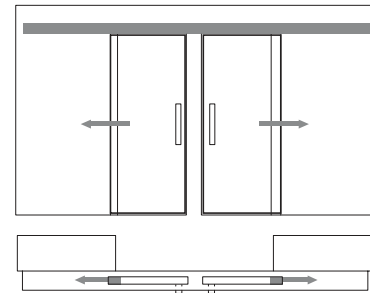
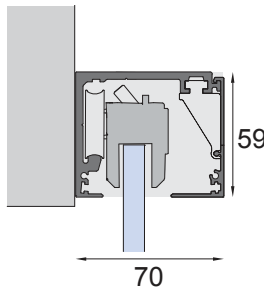
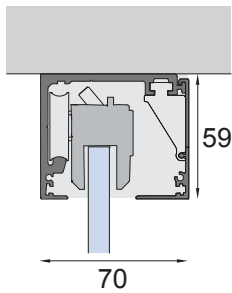
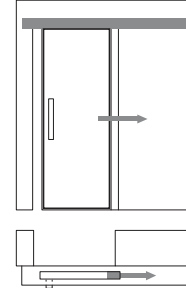

1-WAY TRACK PROFILE WITH FIXED PANEL
1-WEG-LAUFSCHIENE MIT SEITENTEIL
RIEL DE 1 CARRIL CON HOJA FIJA
RAIL 1-VOIE AVEC PANNEAU FIXE

CEILING INSTALLATION
DECKENMONTAGE
A TECHO
PLAFOND

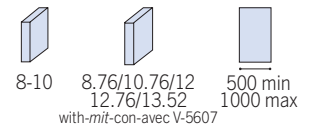

V-5603 / V-5653 / V-5703

Technical pages - Technische Seiten - Páginas Técnicas - Pages Techniques ► 179

ceiling
Decke / a techo / plafond

wall
Wand / a pared / mur

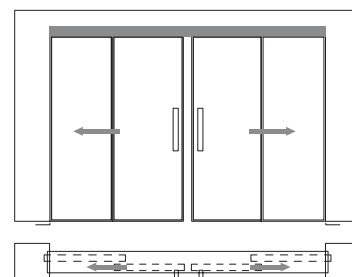
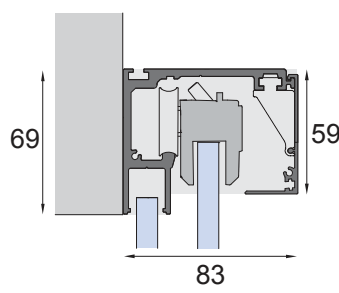
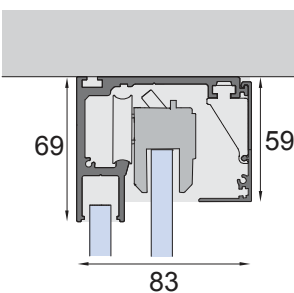
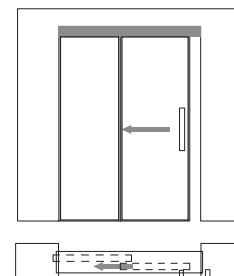

INVISIBLE 1-WAY TRACK PROFILE
 UNSICHTBARE 1-WEG-LAUFSCHIENE
 INVISIBLES RIEL DE 1 CARRIL
 RAIL 1-VOIE INVISIBLE

CEILING INSTALLATION
 DECKENMONTAGE
 A TECHO
 PLAFOND

WALL INSTALLATION
 WANDMONTAGE
 A PARED
 MUR

8-10 8,76/10,76/12
 12,76/13,52
 500 min
 1000 max
 with-mit-con-avec V-5607

V-7600 + V-7605

Technical pages - Technische Seiten - Páginas Técnicas - Pages Techniques ► 180

ceiling
 Decke / a techo / plafond

wall
 Wand / a pared / mur

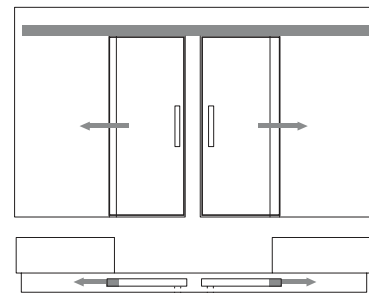
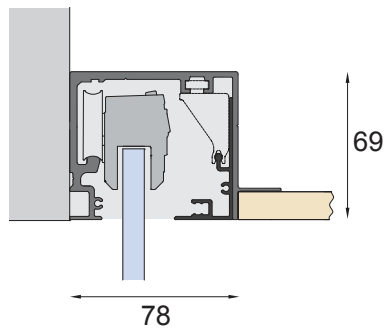
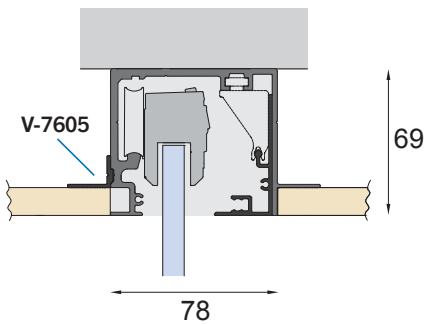
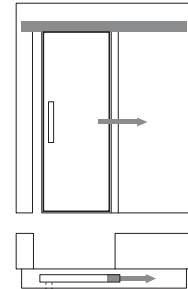

INVISIBLE 1-WAY TRACK PROFILE WITH FIXED PANEL
 UNSICHTBARE 1-WEG-LAUFSCHIENE MIT SEITENTEIL
 INVISIBLES RIEL DE 1 CARRIL CON HOJA FIJA
 RAIL 1-VOIE INVISIBLE AVEC PANNEAU FIXE

A SOFFITTO
 CEILING INSTALLATION
 DECKENMONTAGE
 A TECHO
 PLAFOND

8-10 8,76/10,76/12
 12,76/13,52
 500 min
 1000 max
 with-mit-con-avec V-5657

V-7603 + V-7605

Technical pages - Technische Seiten - Páginas Técnicas - Pages Techniques ► 181

ceiling
 Decke / a techo / plafond

wall
 Wand / a pared / mur

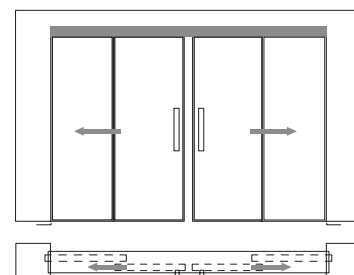
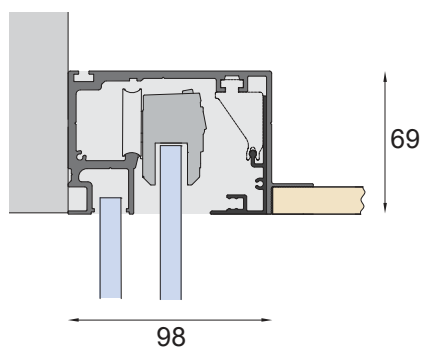
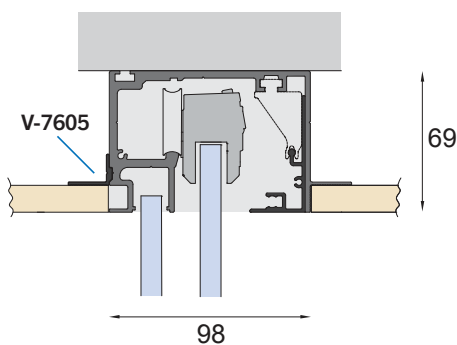
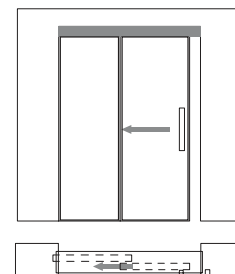

ESSENZA - Ri-EVOLUTION

INVISIBLE TRACK PROFILES - UNSICHTBARE LAUFSCHIENEN - RIELES INVISIBLES - RAILS INVISIBLES

INVISIBLE 1-WAY TRACK PROFILE
UNSICHTBARE 1-WEG-LAUFSCIENE
INVISIBLES RIEL DE 1 CARRIL
RAIL 1-VOIE INVISIBLE

WALL INSTALLATION
WANDMONTAGE
A PARED
MUR

8-10 8.76/10.76/12
 12.76/13.52 500 min
 1000 max
with-mit-con-avec V-5607

V-7650

Technical pages - Technische Seiten - Páginas Técnicas - Pages Techniques ► 182

wall
Wand / a pared / mur

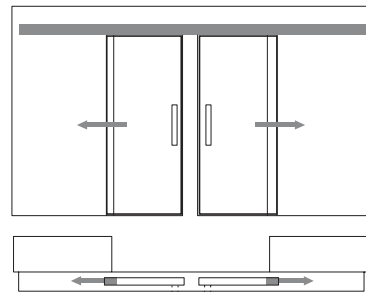
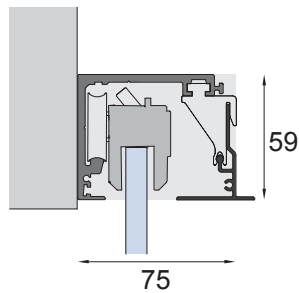
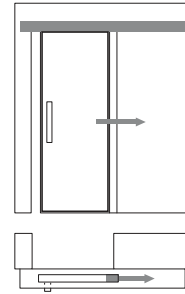

1-WAY TRACK PROFILE
 1-WEG-LAUFSCHIENE
 RIEL DE 1 CARRIL
 RAIL 1-VOIE

CEILING INSTALLATION
 DECKENMONTAGE
 A TECHO
 PLAFOND

WALL INSTALLATION
 WANDMONTAGE
 A PARED
 MUR



V-1900

ceiling
 Decke / a techo / plafond

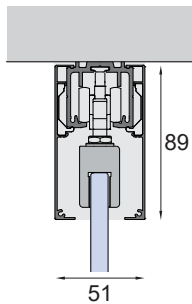

wall
 Wand / a pared / mur

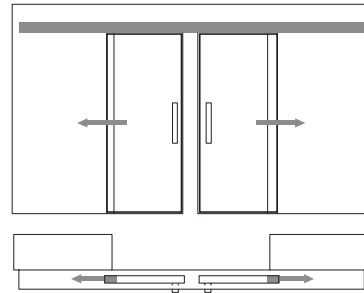
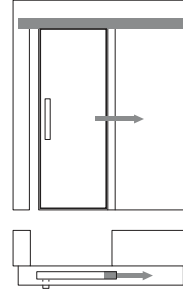
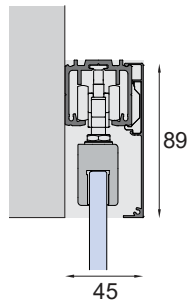

Technical pages
 Technische Seiten
 Páginas Técnicas
 Pages Techniques



1-WAY TRACK PROFILE WITH FIXED PANEL
 1-WEG-LAUFSCHIENE MIT SEITENTEIL
 RIEL DE 1 CARRIL CON HOJA FIJA
 RAIL 1-VOIE AVEC PANNEAU FIXE

CEILING INSTALLATION
 DECKENMONTAGE
 A TECHO
 PLAFOND

WALL INSTALLATION
 WANDMONTAGE
 A PARED
 MUR

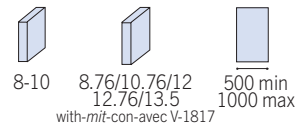

V-1903

ceiling
 Decke / a techo / plafond

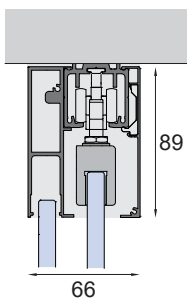

wall
 Wand / a pared / mur

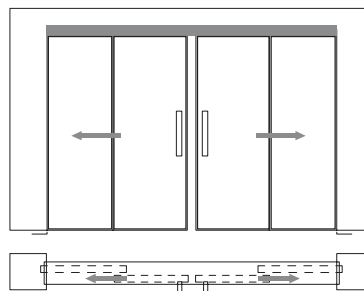
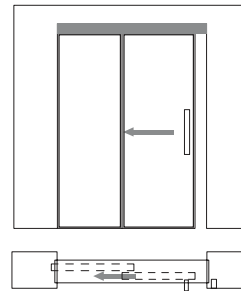
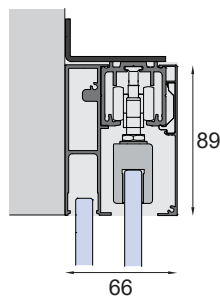

Technical pages
 Technische Seiten
 Páginas Técnicas
 Pages Techniques



