

PA-750 LIBRO FOLDING do-it-yourself

SCORREVOLI A LIBRO / SLIDING FOLDING SYSTEMS / FALT-SCHIEBEWANDSYSTEME

MY METALGLAS



- Sistema scorrevole a libro con profili fermavetro continui a misura standard (mm 1000) da tagliare secondo necessità a cura del cliente, completi di catenaccioli fermaanta a posizionamento esterno regolabile. Vantaggi di una consegna più veloce e di un unico prodotto a magazzino per tutte le misure fino a 800 mm.
- Sliding folding door system with continuous glass fixing profiles of a standard size (mm 1000) to be cut on the basis of client's requirements comes equipped with an adjustable door holding latch positioned externally. The advantage of this product is quick delivery and a unique product available in the warehouse for all sizes up to 800 mm.
- Schiebesystem mit durchgehenden Glasleistenprofilen in Standardgröße (1000 mm), ablängbar, komplett mit äußerem einstellbaren Riegeln zur Flügelfeststellung. Vorteile einer raschen Lieferung und eines einzigen lagermäßigen Produktes mit Abmessungen bis 800 mm.

SCORREVOLI A LIBRO
SLIDING FOLDING SYSTEMS

	PA-750 SET 2 (A)(E)
	PA-750 SET 3 (A)(B)(D)
	PA-750 SET 4 (A)(B)(C)(E)
	PA-750 SET 5 (A)(B)(C)(B)(D)
	PA-750 SET 6 (A)(B)(C)(B)(C)(E)
	PA-750 SET 7 (A)(B)(C)(B)(C)(B)(D)

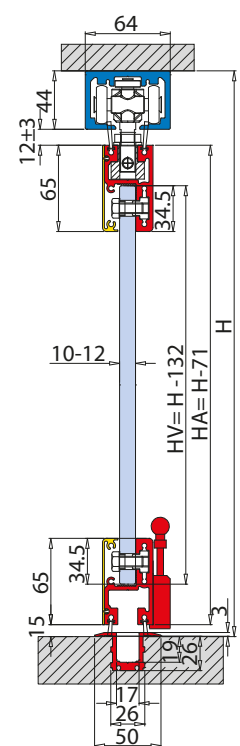

HV = H - 132

PA-750 LIBRO FOLDING do-it-yourself

COME USARE **MY METALGLAS** / HOW TO USE **MY METALGLAS** / WIE MAN BENUTZT **MY METALGLAS**

1 INSERIRE LE MISURE DEL TUO VANO E LE ANTE DESIDERATE
ENTER THE MEASUREMENTS OF YOUR OPENING AND THE DOORS YOU REQUIRE
GEBEN SIE DIE MASSE IHRER ÖFFNUNG EIN UND DIE ERFORDERLICHEN TÜREN

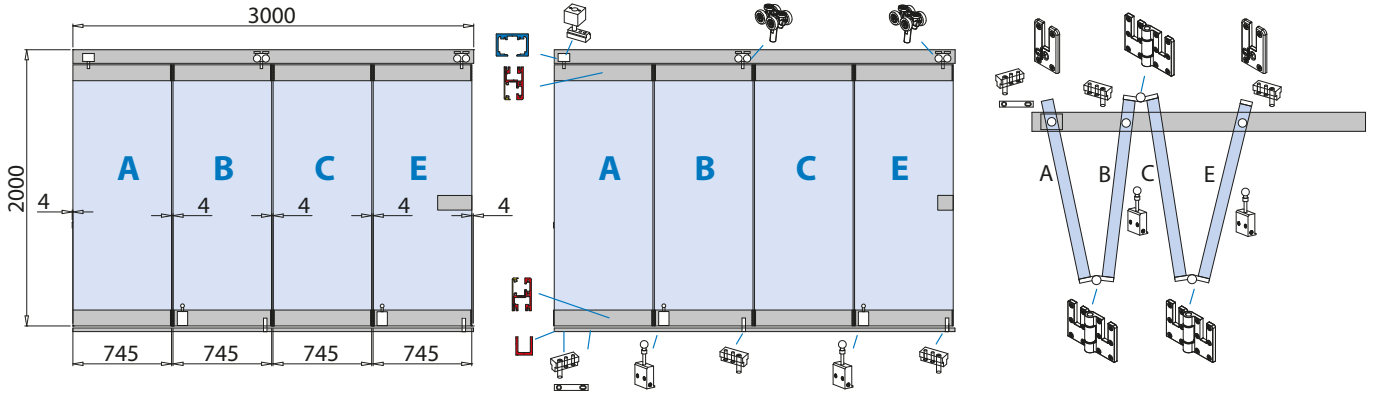

2 SI OTTENGONO LE MISURE DEI VETRI AUTOMATICAMENTE
THE MEASUREMENTS OF THE GLASS WILL BE GENERATED AUTOMATICALLY
DIE ABMESSUNGEN DES GLASES WERDEN AUTOMATISCH BERECHNET

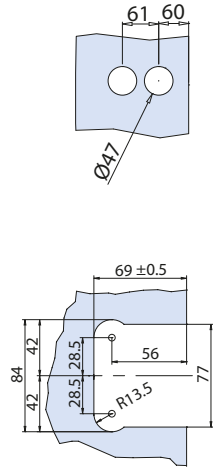
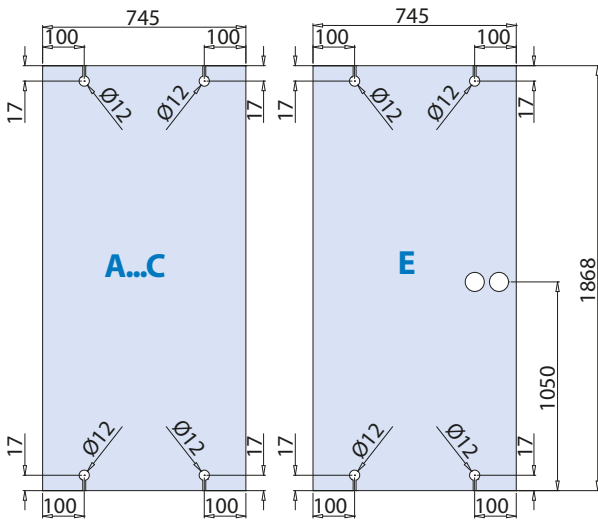

- Foratura vetro porta battente per serrature orizzontali optional
- Glass preparation pivot door for optional horizontal locks
- Glasbearbeitung Dreh-Flügel für optionale horizontale Schlösser

- Foratura vetro porta battente per serrature optional V-504, V-505, V-518, V-519, V-520
- Glass preparation pivot door for optional locks V-504, V-505, V-518, V-519, V-520
- Glasbearbeitung Dreh-Flügel für optionale Schlösser V-504, V-505, V-518, V-519, V-520

3 SI OTTENGONO LE DISTINTE DI TAGLIO DEI PROFILI, DA ABBINARE AGLI ACCESSORI
THE CUTTING SPECIFICATIONS OF THE PROFILES ARE OBTAINED, FOR MATCHING WITH THE ACCESSORIES
SIE ERHALTEN EINE SPEZIFIKATION DER PROFILLÄNGEN ZUM ABGLEICHEN MIT DEM ZUBEHÖR

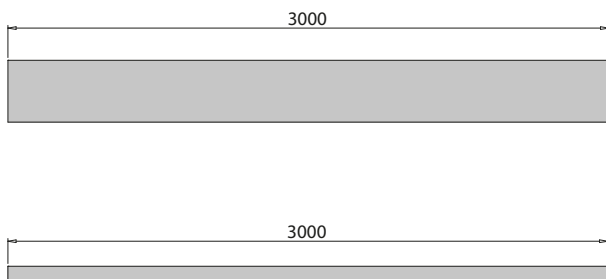







L-150



L-113



	PA-750 SET 2 (A)(E)
	PA-750 SET 3 (A)(B)(D)
	PA-750 SET 4 (A)(B)(C)(E)
	PA-750 SET 5 (A)(B)(C)(B)(D)
	PA-750 SET 6 (A)(B)(C)(B)(C)(E)
	PA-750 SET 7 (A)(B)(C)(B)(C)(B)(D)

PA-750 LIBRO FOLDING do-it-yourself

COME ASSEMBLARE LE ANTE / HOW TO ASSEMBLE THE DOORS / WIE DIE TÜREN ZUSAMMENSETZT WERDEN

TAGLIO PROFILI
PROFIL PREPARATION / PROFILBEARBEITUNG



KIT ACCESSORI
ACCESSORY SETS / ZUBEHÖR SETS



ANTA COMPLETA
COMPLETE DOOR / KOMPLETTE TÜR

ANTA A / DOOR A / TÜRA

PA-730 (x 2)



SUPERIORE / TOP / OBEN

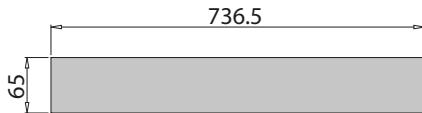

INFERIORE / BOTTOM / UNTEN

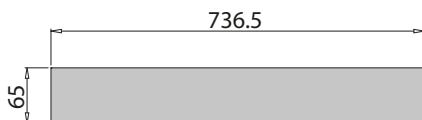

PA-750 ANTA A (for glass 10/12 mm)

PRIMA ANTA A LIBRO A
FIRST FOLDING PANEL A
ESTES FALTELEMENT A

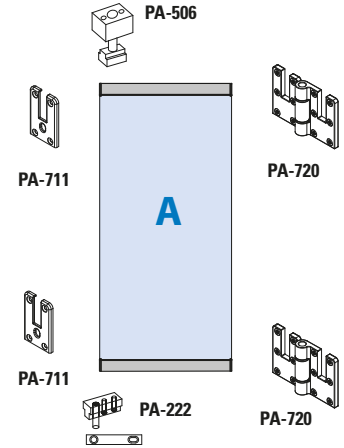
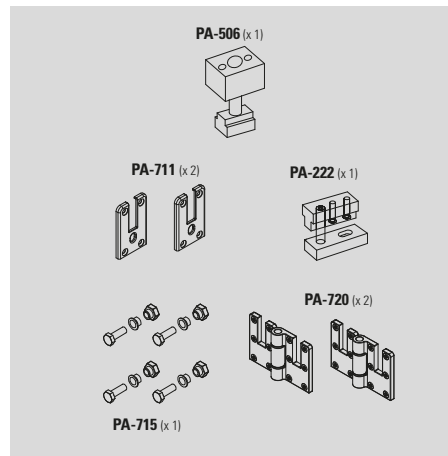

ANTA B / DOOR B / TÜRB

PA-730 (x 2)



SUPERIORE / TOP / OBEN

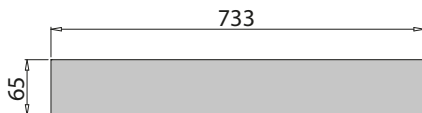

INFERIORE / BOTTOM / UNTEN

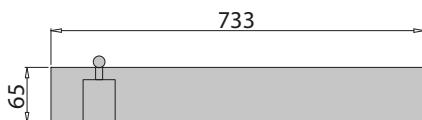

PA-750 ANTA B (for glass 10/12 mm)

ANTA INTERMEDIA A LIBRO B
INTERMEDIATE FOLDING PANEL B
MITTIGES FALTELEMENT B

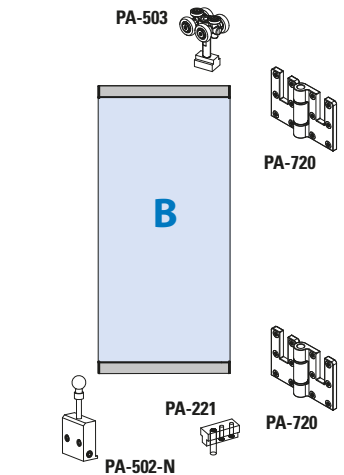
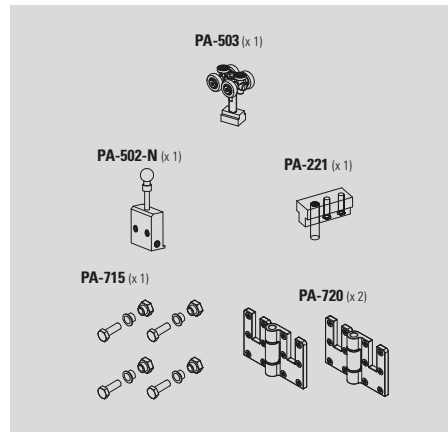

ANTA C / DOOR C / TÜRC

PA-730 (x 2)



SUPERIORE / TOP / OBEN

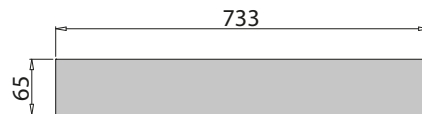

INFERIORE / BOTTOM / UNTEN

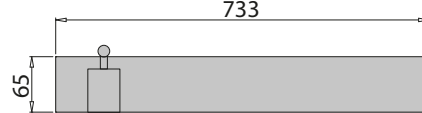

PA-750 ANTA C (for glass 10/12 mm)

ANTA INTERMEDIA A LIBRO 2 C
INTERMEDIATE FOLDING PANEL 2 C
MITTIGES FALTELEMENT 2 C

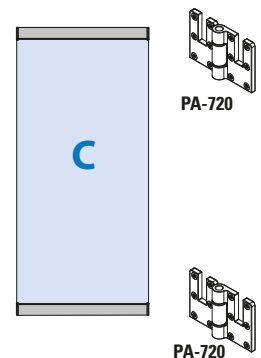
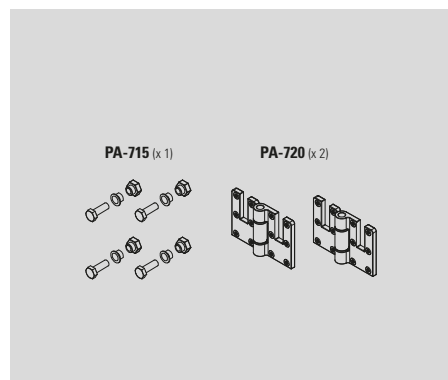

SCORREVOLI A LIBRO
SLIDING FOLDING SYSTEMS

PA-750 LIBRO FOLDING do-it-yourself

COME ASSEMBLARE LE ANTE / HOW TO ASSEMBLE THE DOORS / WIE DIE TÜREN ZUSAMMENSETZT WERDEN

TAGLIO PROFILI
PROFILES PREPARATION / PROFILEBEARBEITUNG



KIT ACCESSORI
ACCESSORY SETS / ZUBEHÖR SETS



ANTA COMPLETA
COMPLETE DOOR / KOMPLETTE TÜR

ANTA D / DOOR D / TÜR D

PA-730 (x 2)



SUPERIORE / TOP / OBEN

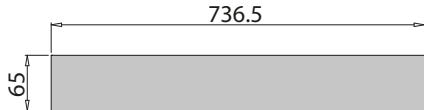

INFERIORE / BOTTOM / UNTEN

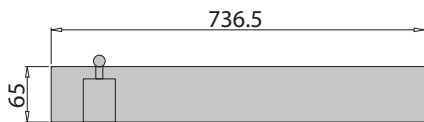

PA-750 ANTA D (for glass 10/12 mm)
ULTIMA ANTA E PORTA BATTENTE D (ante dispari)
LATERAL PIVOT DOOR D (odd panels)
LETZTER DREH-FLÜGEL D (ungerade Zahl von Flügeln)

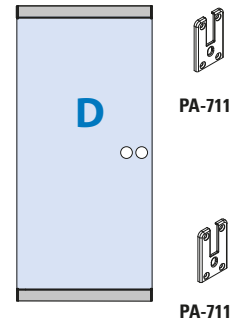
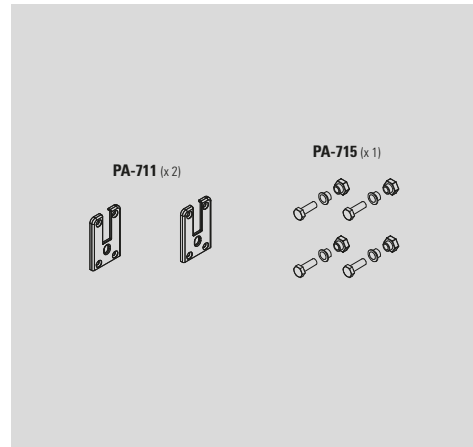

SCORREVOLI A LIBRO
SLIDING FOLDING SYSTEMS

ANTA E / DOOR E / TÜR E

PA-730 (x 2)



SUPERIORE / TOP / OBEN

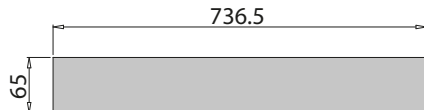

INFERIORE / BOTTOM / UNTEN

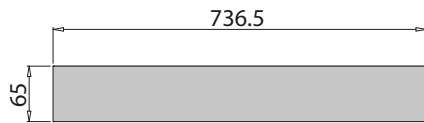

PA-750 ANTA E (for glass 10/12 mm)
ULTIMA ANTA E (ante pari)
LAST PANEL E (even panels)
ENDSCHIEBEFLÜGEL E (gerade Zahl von Flügeln)

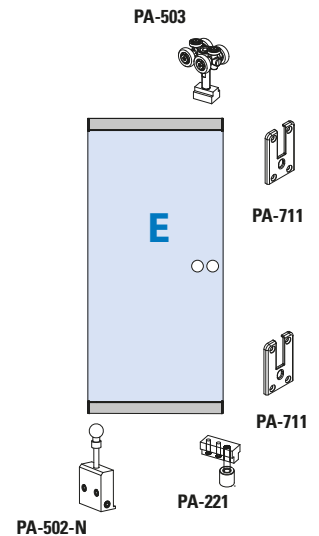
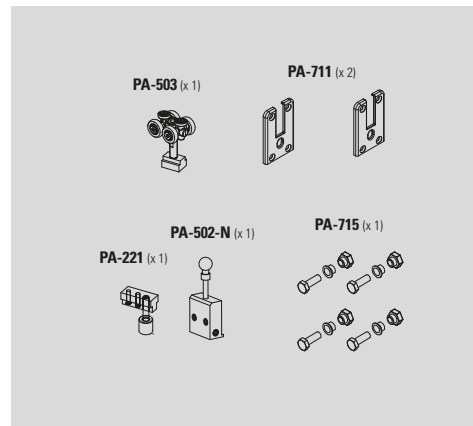

ANTA F / DOOR F / TÜR F

PA-730 (x 2)



SUPERIORE / TOP / OBEN

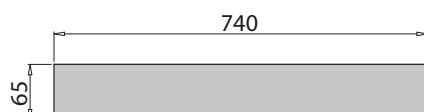

INFERIORE / BOTTOM / UNTEN

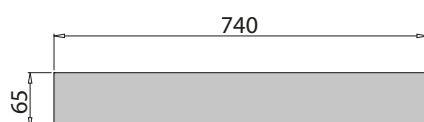

PA-750 ANTA F (for glass 10/12 mm)
PORTA LATERALE FISSA F
FIXED LATERAL PIVOT DOOR F
FEST DREHFLÜGEL F

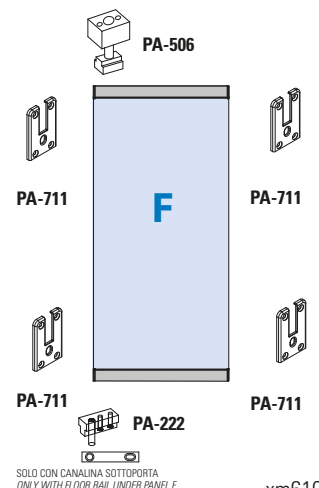
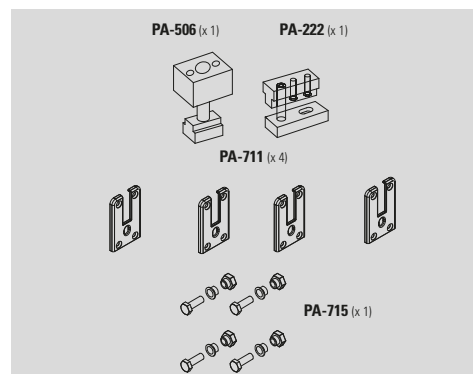



SCORREVOLI A LIBRO
SLIDING FOLDING SYSTEMS