



FUS
 PANEL - TÜR - PUERTA - PORTE

—

DIV-204
 CROSS PROFILE - QUERPROFIL - TRAVESAÑO
 - TRAVERSE

NO
 FINISHING - OBERFLÄCHE - ACABADO - FINITION

—

FUS-1950 DEA
 INVISIBLE SYSTEM FOR SUSPENDED CEILING
 SYSTEM FÜR ABGEHÄNGTE DECKE
 SISTEMA INVISIBLE EMPOTRADO EN EL TECHO
 SYSTEME INVISIBLE ENCASTRE DANS LE PLAFOND

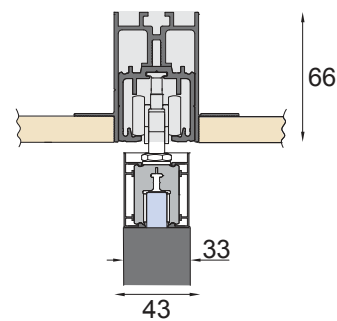

FUSION SLIDING COLLECTION



PROFILE ASSEMBLY - PROFILMONTAGE - MONTAJE DE PERFILES - ASSEMBLAGE DE PROFILS

A winning, fast and safe system for aligning and assembling profiles.
 Ein optimales, schnelles und sicheres System zur Profilausrichtung und -montage.
 Un sistema ganador, rápido y seguro para la alineación y montaje de perfiles.
 Un système performant, rapide et sûr pour aligner et assembler les profilés.

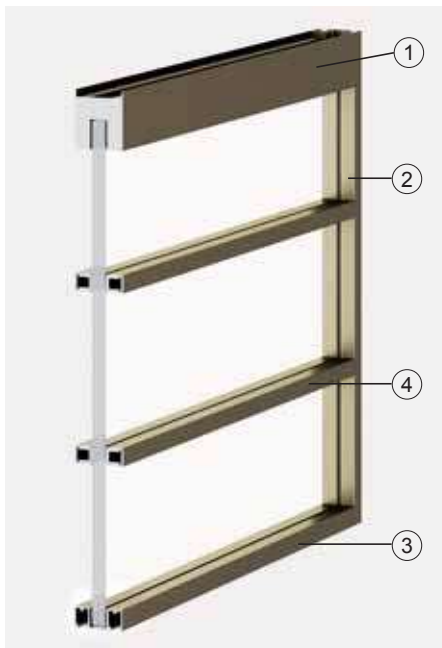

PANEL SET

FUS-995
 995 x 2980 mm
FUS-1495
 1495 x 2980 mm

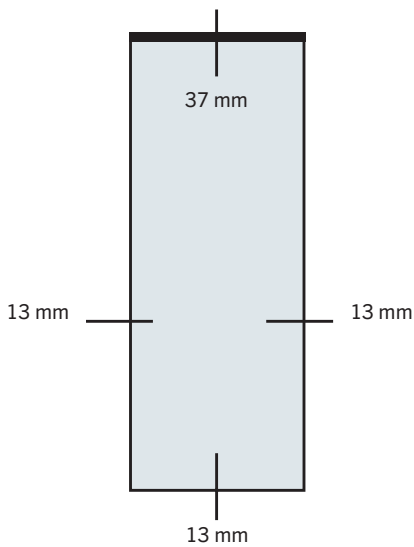
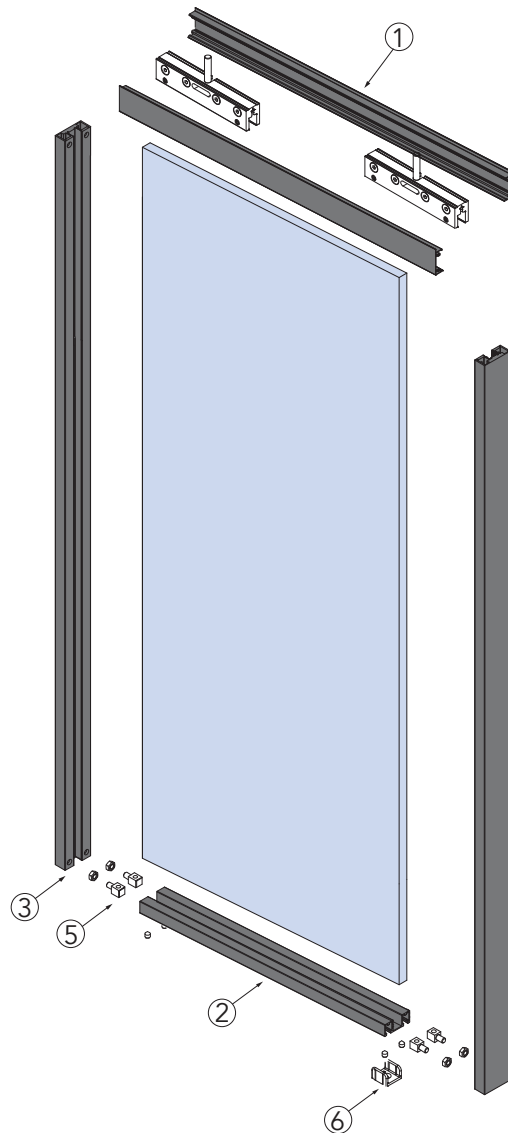

- ① Kit with 2 top clamps V-104 and 2 cover profiles
 Kit mit 2 Klemmschuhe V-104 und 2 Abdeckungen
 Juegos de pinzas superiores V-104 y 2 perfiles cobertores FUS-104
 Kit de 2 pinces supérieures V-104 et 2 profils de recouvrement FUS-104
- ② Horizontal bottom profile DIV-203
 Unterer Horizontalprofil DIV-203
 Transversal inferior DIV-203
 Traverse inférieure DIV-203
- ③ Vertical profile DIV-202
 Vertikalprofil DIV-202
 Vertical DIV-202
 Profil vertical DIV-202
- ④ Cross profile DIV-204
 Querprofil DIV-204
 Travesaño DIV-204
 Traverse DIV-204

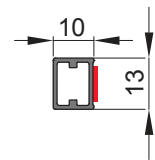
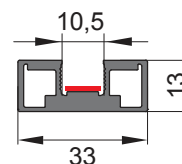
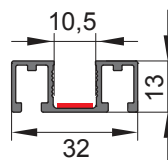
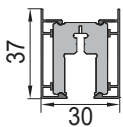

- ⑤ Assembly kit P-F38
 Montage-Kit P-F38
 Kit de montage P-F38
 Kit de montage P-F38

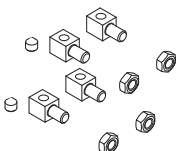

- ⑥ Door guide DIV-012
 Bodenführung DIV-012
 Guía de puerta DIV-012
 Guide de la porte DIV-012



- ⑦ DRILLING TEMPLATE DIV-01
 Bohrschablone DIV-01
 Plantilla de perforado DIV-01
 Gabarit de perçage DIV-01

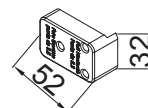



DIV-009

DIV-010



FLUSH WALL
 WANDBÜNDIG - EMPOTRADO ENTRE PAREDES - MUR AFFLEURANT

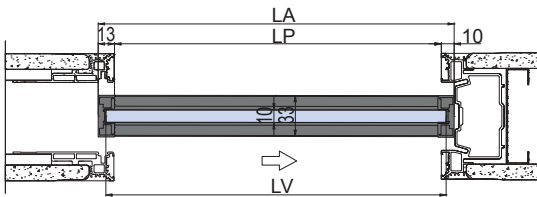

WITH DOOR FRAME TS-04
 MIT ZARGE TS-04 - CON JAMBA TS-04 - AVEC ENCADREMENT TS-04

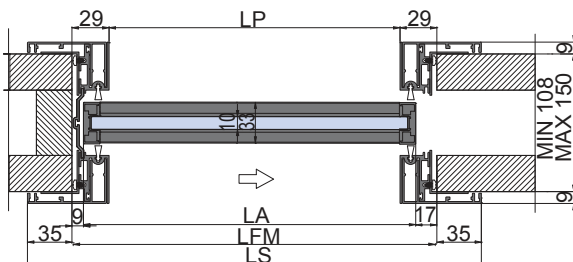



FUS
PANEL - TÜR - PUERTA - PORTE

—

NO
FINISHING - OBERFLÄCHE - ACABADO - FINITION

FUS-1950 DEA
SYSTEM FOR POCKET DOORS
SYSTEM FÜR IN DER WAND LAUFENDE TÜREN - SISTEMA PARA PUERTAS CORREDERAS EMPOTRADAS
- SYSTEME POUR PORTE COULISSANTE A GALANDAGE

—

DIV-009 + DIV-010
LOCK + PULL-LEVER
SCHLOSS + STIRNGRIFF - CERRADURA + MANILLA DE ARRASTRE
- SERRURE + GARNITURE D'ENTRAÎNEMENT

SLIDING DOORS