

PA-300 PARK LINE 2

SCORREVOLI A PARCHEGGIO / SLIDING STACKING SYSTEMS / GANZGLAS-SCHIEBEWANDSYSTEME

- Sistema scorrevole a parcheggio con profili fermavetro su misura richiesta dal cliente, senza fori nel vetro e con possibilità di porta centrale a battente e parcheggiabile.
- Sliding stacking system with glass fixing profiles made to measure upon client's request, no need to make holes in the glass and with the possibility of hinged and parkable center panel.
- Schiebesystem mit Parkraum, mit kundenspezifischen Glasleistenprofile mit zentraler Drehtür und Parkmöglichkeit.

MY METALGLAS

SCORREVOLI A PARCHEGGIO
SLIDING STACKING SYSTEMS

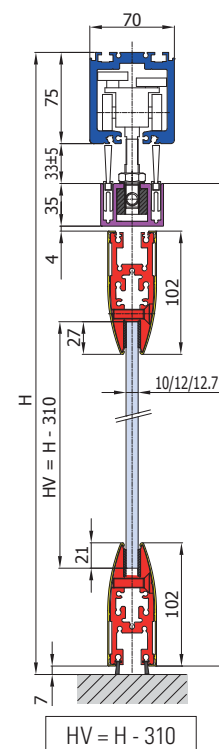
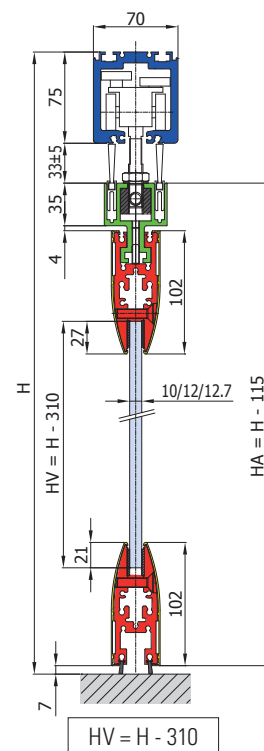

- Porta centrale scorrevole
- Center sliding pivoted door
- Dreh/pendel Schiebefügel

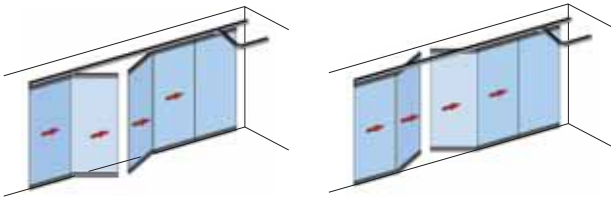

10-12-12,7	150 Kg	110 Kg	3500 550 min 1250 max
------------	--------	--------	-----------------------------

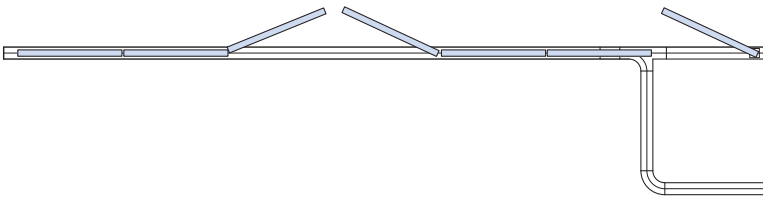

PA-108

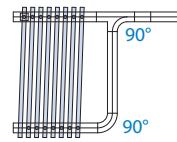

PA-109

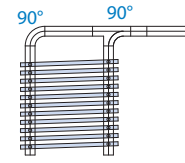

PA-113

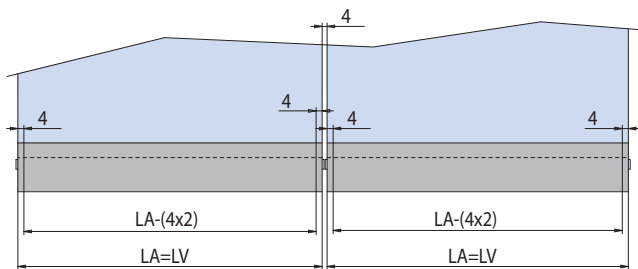
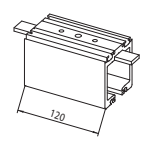

- Baie da ordinare a parte oltre alle ante, altre baie disponibili da pag. **66**
- To be ordered separately from the panels, other parking bays available from page **66**
- Neben den Flügel extra zu bestellen, andere Parkräume auf Seite **66**

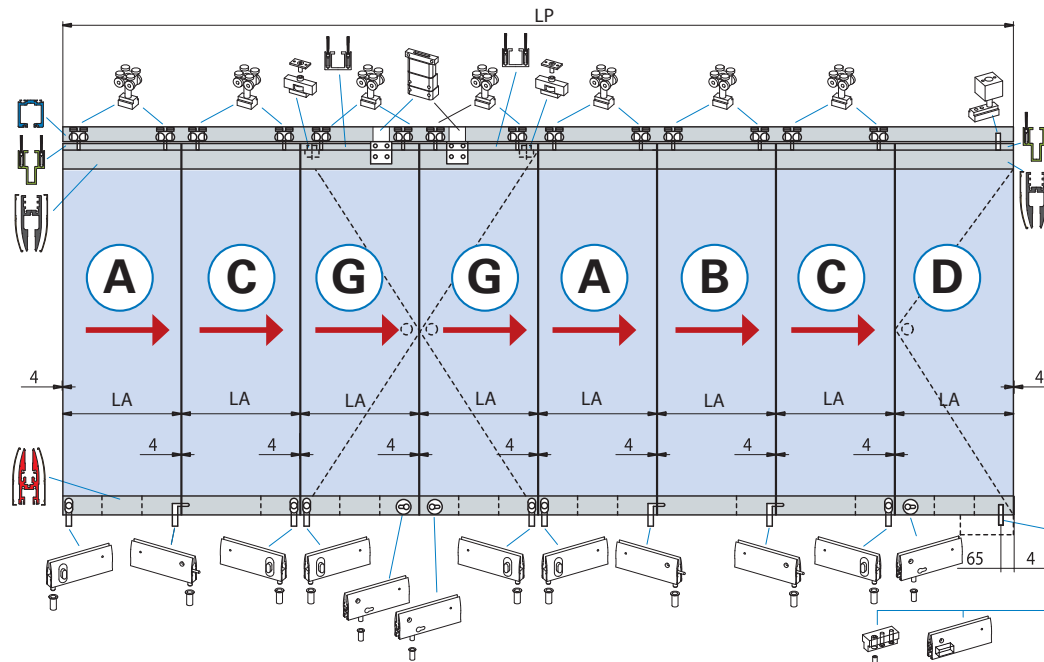

- Calcolo vetro
- Calculation glass
- Glasberechnung

At = 4 x (N + 1)
X = LP - At
LA = LV = X / N

- (A)**
 - Prima anta
 - First panel
 - Erster Schiebeflügel
- (B)**
 - Anta intermedia
 - Intermediate panel
 - Zwischen-Schiebeflügel
- (C)**
 - Ultima anta
 - Last panel
 - End-Schiebeflügel
- (D)**
 - Porta laterale
 - Lateral pivot door
 - Dreh-Schiebeflügel
- (G)**
 - Porta centrale scorrevole dx/sx
 - Center sliding pivoted dx/sx
 - Dreh/pendel Schiebeflügel dx/sx

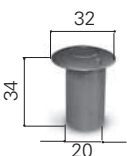

xme295 / xla171BIS-1

AN Alluminio anodizzato Aluminium anodized Aluminium Silberfarbig	At Arie totali Total clearances Summe alle Abstände Glas/Wand	N Numero ante Numbers panels Anzahl der Elemente	LP Passaggio luce Clear opening width Lichte Durchgangsbreite	LA = LV Larghezza ante = Larghezza vetro Panel width = Glass width Flügelbreite = Glasbreite	H Altezza passaggio luce Clear opening height Lichte durchgangshöhe	HV Altezza vetro Glass height Glashöhe	HA Altezza anta Door height Tür Höhe
---	---	--	---	--	---	--	--

PA-632

- Scambio per convertire l'anta porta battente del PA-300 in anta scorrevole parcheggiabile tramite l'apposita chiave snodata
- Mechanism to convert the center pivoted door of PA-300 in sliding door parkable through the appropriate tool
- System um die zentrale Dreh-Tür des PA-300 in Schiebetür durch das entsprechende Werkzeug umzuwandeln

PA-300 CHIAVE



PA-308

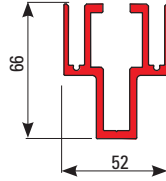

PA-309

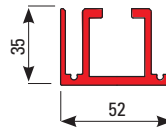

PA-310

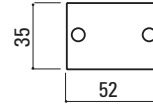

PA-311

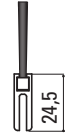

PA-214

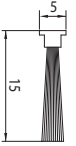

PA-632

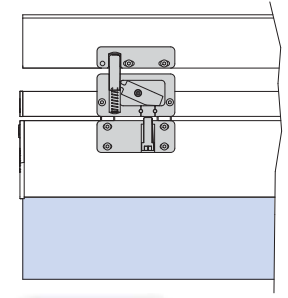
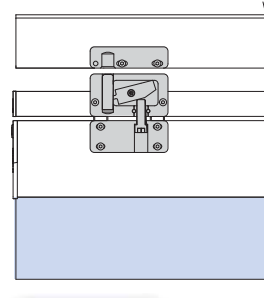
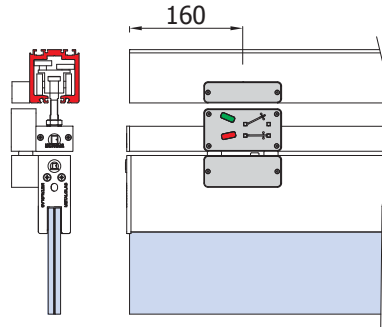
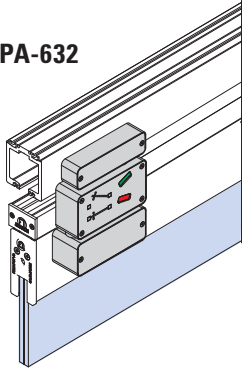

Anta scorrevole
Sliding door



Porta battente
Pivot door

xme527c / xme527e

Sliding



Door





PA-300 PARK LINE 2

COME USARE **MY METALGLAS** / HOW TO USE **MY METALGLAS** / WIE MAN BENUTZT **MY METALGLAS**

1 INSERIRE LE MISURE DEL TUO VANO E LE ANTE DESIDERATE
ENTER THE MEASUREMENTS OF YOUR OPENING AND THE DOORS YOU REQUIRE
GEBEN SIE DIE MASSE IHRER ÖFFNUNG EIN UND DIE ERFORDERLICHEN TÜREN

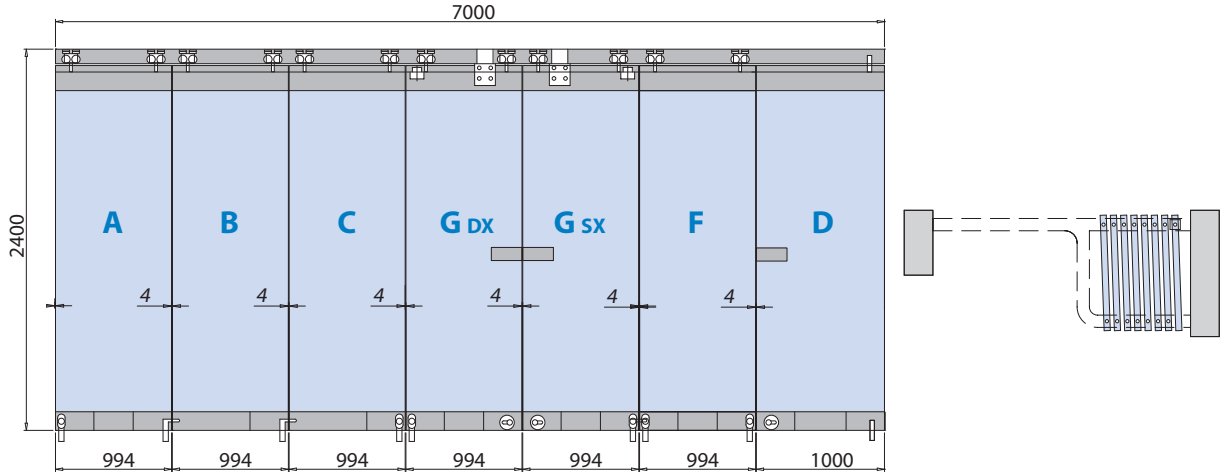

2 SI OTTENGONO LE MISURE DEI VETRI AUTOMATICAMENTE
THE MEASUREMENTS OF THE GLASS WILL BE GENERATED AUTOMATICALLY
DIE ABMESSUNGEN DES GLASES WERDEN AUTOMATISCH BERECHNET

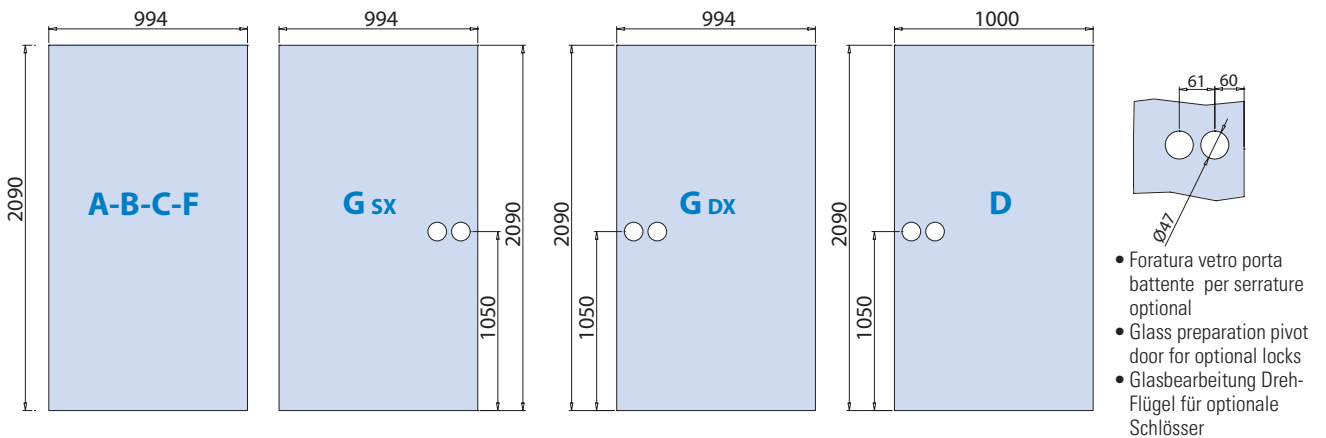

3 SI OTTENGONO LE DISTINTE DI TAGLIO DEI PROFILI, DA ABBINARE AGLI ACCESSORI
THE CUTTING SPECIFICATIONS OF THE PROFILES ARE OBTAINED, FOR MATCHING WITH THE ACCESSORIES
SIE ERHALTEN EINE SPEZIFIKATION DER PROFILLÄNGEN ZUM ABGLEICHEN MIT DEM ZUBEHÖR

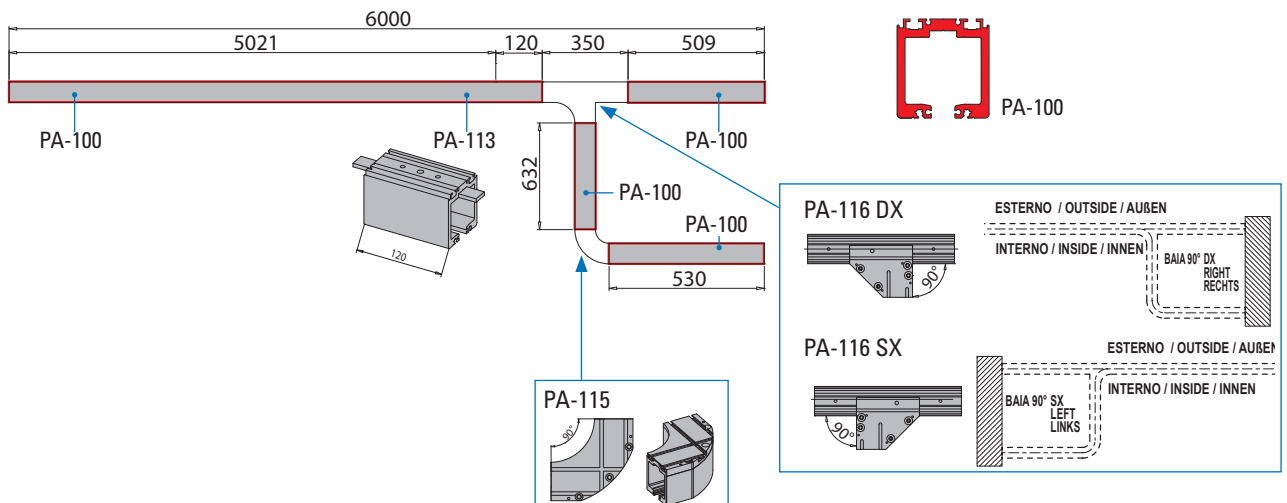

PA-300 PARK LINE 2

COME ASSEMBLARE LE ANTE / HOW TO ASSEMBLE THE DOORS / WIE DIE TÜREN ZUSAMMENGESETZT WERDEN

TAGLIO PROFILI / PROFIL PREPARATION / PROFILBEARBEITUNG

ANT A / DOOR A / TÜR A

PA-209 (x 2)
PA-308 (x 1)
PA-210 (x 4)
PA-311 (x 2)

SUPERIORE / TOP / OBEN

INFERIORE / BOTTOM / UNTEN

• Lavorazione veletta con **PA-225 + PA-203-POM**
 • Cover profile preparation with **PA-225 + PA-203-POM**
 • Vorbereitung der Abdeckung mit **PA-225 + PA-203-POM**

PA-300 ANTA A-10 (for glass 10 mm)
PA-300 ANTA A-12 (for glass 12 - 12,7 mm)
 PRIMA ANTA A
 FIRST PANEL A
 ERSTER SCHIEBEFLÜGEL A

ANT A COMPLETA / COMPLETE DOOR / KOMPLETTE TÜR

ANT B / DOOR B / TÜR B

PA-209 (x 2)
PA-308 (x 1)
PA-210 (x 4)
PA-311 (x 2)

SUPERIORE / TOP / OBEN

INFERIORE / BOTTOM / UNTEN

PA-300 ANTA B-10 (for glass 10 mm)
PA-300 ANTA B-12 (for glass 12 - 12,7 mm)
 ANTA INTERMEDIA B
 INTERMEDIATE PANEL B / ZWISCHEN-SCHIEBEFLÜGEL B

ANT B COMPLETA / COMPLETE DOOR / KOMPLETTE TÜR

ANT C / DOOR C / TÜR C

PA-209 (x 2)
PA-308 (x 1)
PA-210 (x 4)
PA-311 (x 2)

SUPERIORE / TOP / OBEN

INFERIORE / BOTTOM / UNTEN

• Lavorazione veletta con **PA-225 + PA-203-POM**
 • Cover profile preparation with **PA-225 + PA-203-POM**
 • Vorbereitung der Abdeckung mit **PA-225 + PA-203-POM**

PA-300 ANTA C-10 (for glass 10 mm)
PA-300 ANTA C-12 (for glass 12 - 12,7 mm)
 ULTIMA ANTA C
 LAST PANEL C
 END-SCHIEBEFLÜGEL C

ANT C COMPLETA / COMPLETE DOOR / KOMPLETTE TÜR

SCORREVOLI A PARCHEGGIO
 SLIDING STACKING SYSTEMS

PA-300 PARK LINE 2

COME ASSEMBLARE LE ANTE / HOW TO ASSEMBLE THE DOORS / WIE DIE TÜREN ZUSAMMENSETZT WERDEN

TAGLIO PROFILI
PROFIL PREPARATION / PROFILBEARBEITUNG



KIT ACCESSORI
ACCESSORY SETS / ZUBEHÖR SETS



ANTA COMPLETA
COMPLETE DOOR / KOMPLETTE TÜR

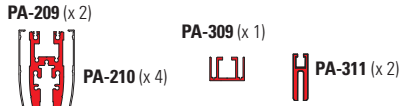

SUPERIORE / TOP / OBEN

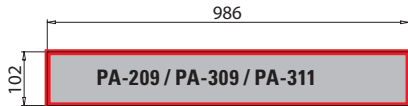

INFERIORE / BOTTOM / UNTEN

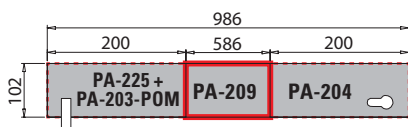

- Lavorazione veletta PA-210 con PA-204 e PA-225 + PA-203-POM
- Cover profile preparation PA-210 with PA-204 and PA-225 + PA-203-POM
- Vorbereitung der Abdeckung PA-210 mit PA-204 und PA-225 + PA-203-POM

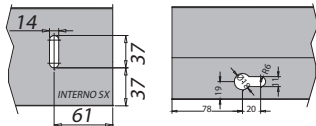

PA-300 ANTA G-10 (for glass 10 mm)
PA-300 ANTA G-12 (for glass 12 - 12,7 mm)
PORTA CENTRALE SCORREVOLE G
CENTER SLIDING PIVOTED DOOR G
DREH/PENDEL SCHIEBEFLÜGEL G

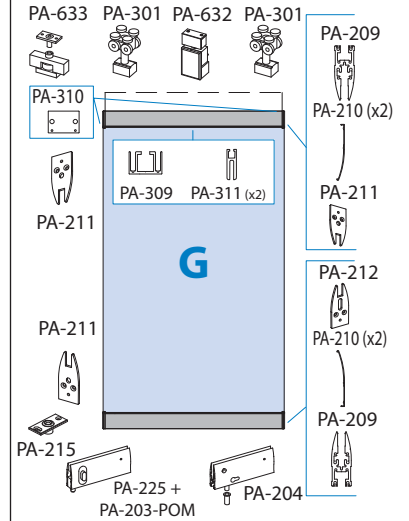

ANTA G / DOOR G / TÜR G

- Lavorazione profili PA-209 / PA-309
- Profiles preparation PA-209 / PA-309
- Vorbereitung der Profile PA-209 / PA-309

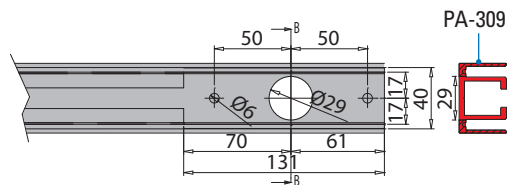
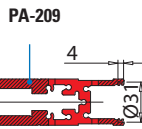
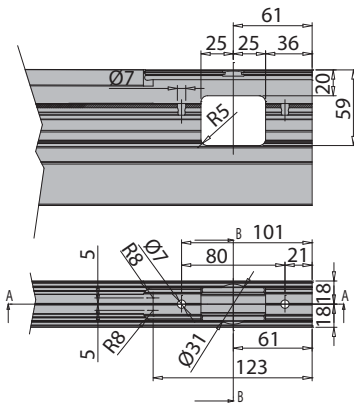

ANTA F / DOOR F / TÜR F

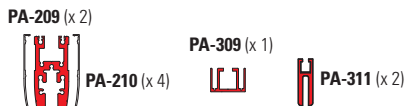

SUPERIORE / TOP / OBEN

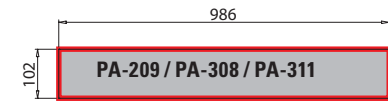

INFERIORE / BOTTOM / UNTEN

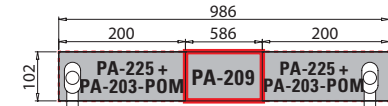

- Lavorazione veletta con PA-225 + PA-203-POM
- Cover profile preparation with PA-225 + PA-203-POM
- Vorbereitung der Abdeckung mit PA-225 + PA-203-POM

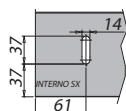

PA-300 ANTA F-10 (for glass 10 mm)
PA-300 ANTA F-12 (for glass 12 - 12,7 mm)
ANTA INTERMEDIA 2 F
INTERMEDIATE PANEL 2 F
ZWISCHEN-SCHIEBEFLÜGEL 2 F

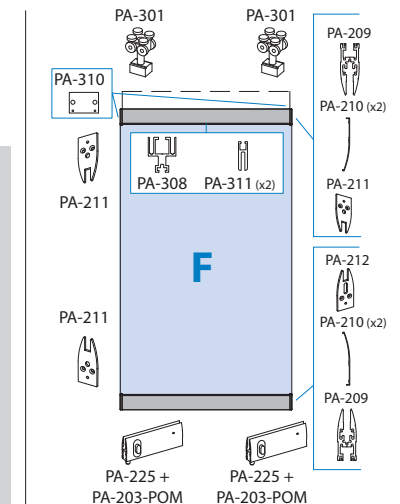
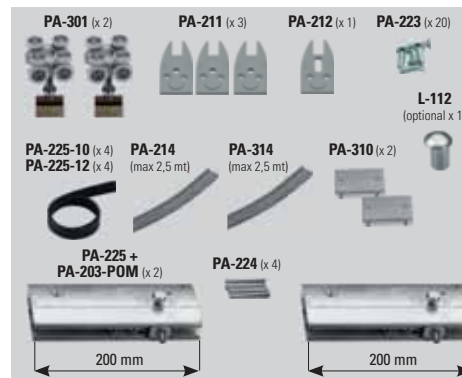

PA-300 PARK LINE 2

COME ASSEMBLARE LE ANTE / HOW TO ASSEMBLE THE DOORS / WIE DIE TÜREN ZUSAMMENSETZT WERDEN

TAGLIO PROFILI
PROFIL PREPARATION / PROFILBEARBEITUNG



KIT ACCESSORI
ACCESSORY SETS / ZUBEHÖR SETS



ANTA COMPLETA
COMPLETE DOOR / KOMPLETTE TÜR

ANTA D / DOOR D / TÜR D

PA-209 (x 2)



PA-308 (x 1)



PA-210 (x 4)



PA-311 (x 2)

SUPERIORE / TOP / OBEN

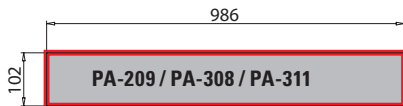

INFERIORE / BOTTOM / UNTEN

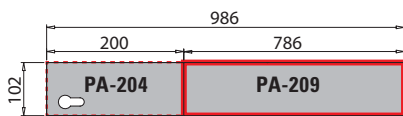

- Lavorazione veletta PA-210 con PA-204
- Cover profile preparation PA-210 with PA-204
- Vorbereitung der Abdeckung PA-210 mit PA-204

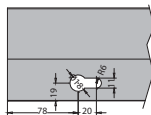

PA-300 ANTA D-10 (for glass 10 mm)
PA-300 ANTA D-12 (for glass 12 - 12,7 mm)
PORTA LATERALE D
LATERAL PIVOT DOOR D
DREH-SCHIEBEFLÜGEL D

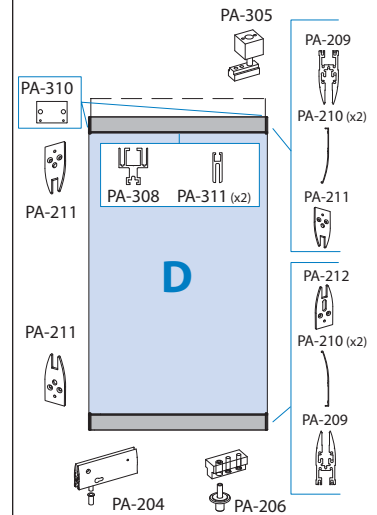

xme540-a

SCORREVOLI A PARCHEGGIO
SLIDING STACKING SYSTEMS

