

MANIGLIONI MINI Ø 16 - Ø 15 / MANIGLIONI PULLHANDLES / STOSSGRIFFE

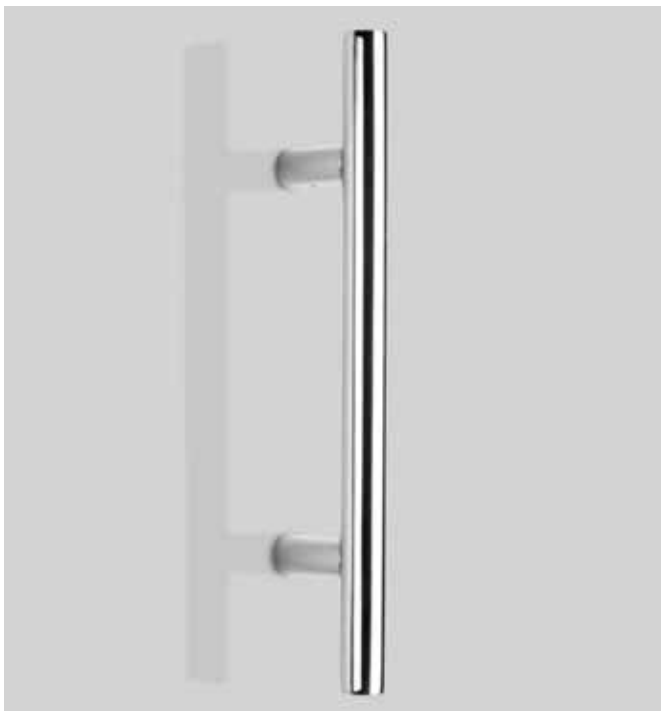

Round Mini Ø 16

- Paio maniglioni inox
- Pair pullhandles inox
- Paar Stossgriffe inox

IX - IL

	TL	225	300	
		135		• Ø 9
A		200		• Ø 9

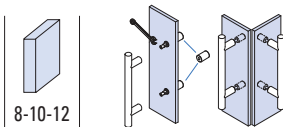
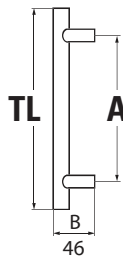

Option with
Knob **B-177**
page **206**

8-10-12



Square Mini Ø 15

- Paio maniglioni inox
- Pair pullhandles inox
- Paar Stossgriffe inox

IX - IL

	TL	150	215	315	
		135			• Ø 10
A		200			• Ø 10
			300		• Ø 10

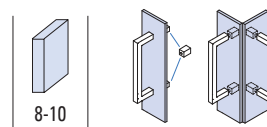
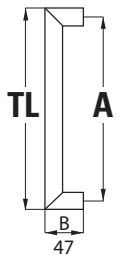

Option with
Knob **B-178**
page **206**

8-10

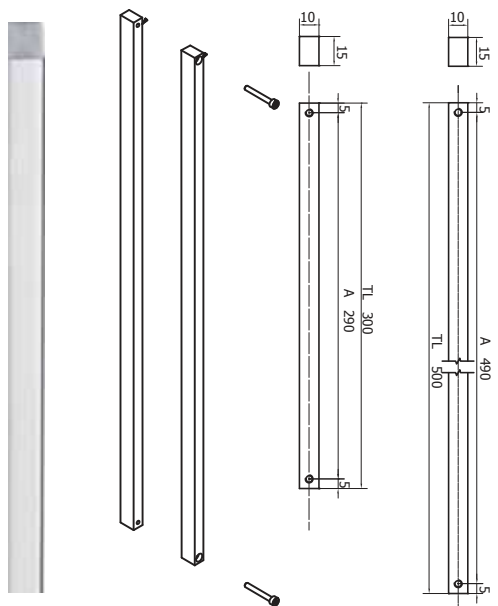

SQUARE 10

- Paio maniglioni
- Pair pullhandles
- Paar Stossgriffe

AN - CR - NS

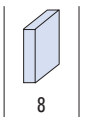

8

Ø	Code	A	TL		Materiale Material Material	Unit.	Finitura Finishes Oberfläche
10 x 15	10.41.53/290.300	290	300	8	Ottone Brass Messing	Paio Pair Paar	CR
10 x 15	10.41.63/290.300	290	300	8	Alluminio Aluminium Aluminium	Paio Pair Paar	CR
10 x 15	10.41.73/290.300	290	300	8	Alluminio Aluminium Aluminium	Paio Pair Paar	NO
10 x 15	10.41.53/490.500	490	500	8	Ottone Brass Messing	Paio Pair Paar	CR
10 x 15	10.41.63/490.500	490	500	8	Alluminio Aluminium Aluminium	Paio Pair Paar	CR



Foro vetro
Glass hole
Glasbohrung

IX
Acciaio inox satinato
Satin stainless steel
Edelstahl matt

IL
Acciaio inox lucido
Polished stainless steel
Edelstahl poliert

MANIGLIONI \varnothing 15

PULLHANDLES / STOSSGRIFFE



SQUARE \varnothing 15

- Paio maniglioni. Materiale: Alluminio
 - Pair pullhandles. Material: Aluminium
 - Paar Stossgriffe. Material: Aluminium
- AN - AL - NS - NO

	TL	174	206	334	
	160	•			\varnothing 10
A	192		•		\varnothing 10
	320			•	\varnothing 10

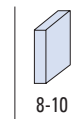

Foro vetro
Glass hole
Glasbohrung

AL
Alluminio lucido
Polished aluminium
Aluminium glänzend

NO
Nero opaco
Matt black
Schwarz matt

AN
Alluminio anodizzato
Aluminium anodized
Aluminium Silberfarbig

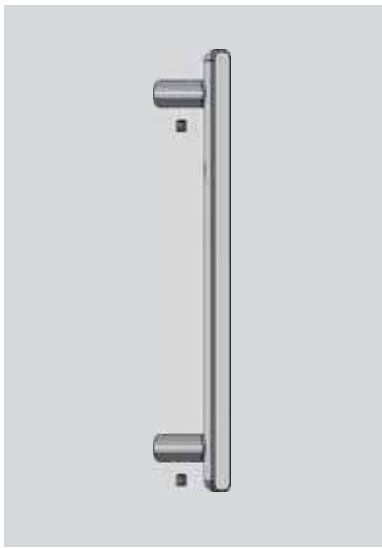

NS
Nickel satinato
Satin nickel
Ähnlich Edelstahl matt

MANIGLIONI "ZAMA" PULLHANDLES ZAMAK / STOSSGRIFFE ZAMAK



SQ01 / SQ02

- Maniglione. Materiale: Zama
 - Pullhandle. Material: Zamak
 - Stossgriff. Material: Zamak
- CR

Code	A	TL		
SQ01	160	200	M4	Ø 6
SQ02	160	200	M4	Ø 6

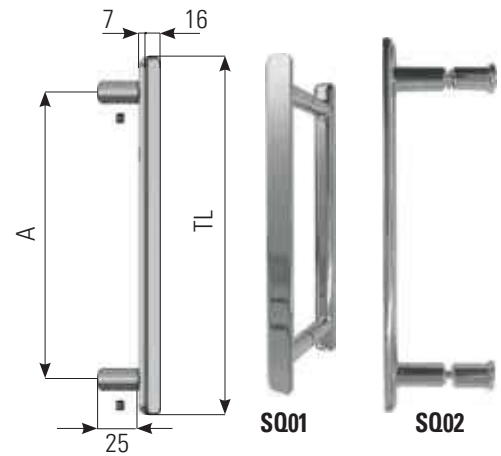

PORTASALVIETTE TOWEL BARS / HANDTUCHHALTER



B-120

- Portasalvietta montato a vetro L=600 mm, pomolino B-122 optional.
 - Glass mounted towel bar L=600 mm, knob B-122 optional.
 - Handtuchhalter für Glas L=600 mm, Knopf B-122 optional.
- CR

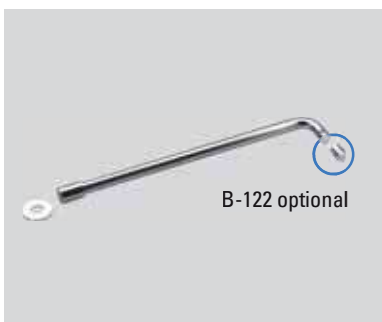
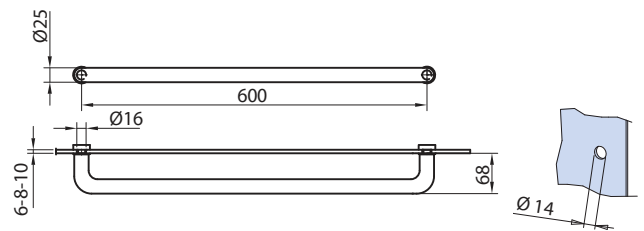

B-121

- Portasalvietta montato a vetro/muro L=600 mm, pomolino B-122 optional.
 - Glass/wall mounted towel bar L=600 mm, knob B-122 optional.
 - Handtuchhalter für Glas/Wand L=600 mm, Knopf B-122 optional.
- CR

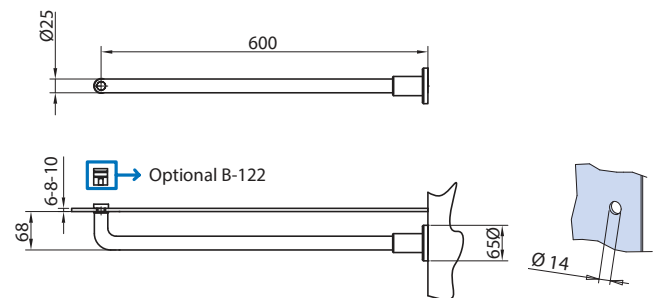

B-122

- Pomolo optional per portasalvietta.
 - Knob optional for towel bar.
 - Knopf optional für Handtuchhalter.
- CR

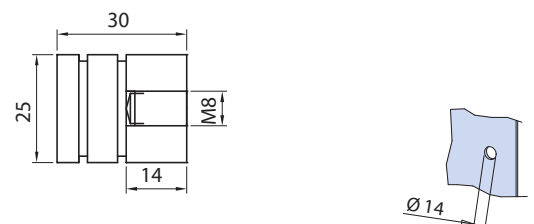

B-186

- Pomolo appendi salvietta montato a vetro.
- Knob towel bar for glass.
- Knopf Handtuchhalter, für Glas.

CR

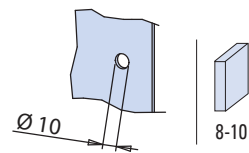
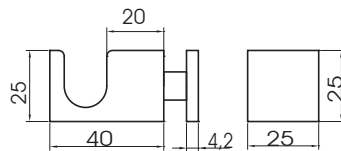
B-124

- Portasalvietta montato a vetro L-469 mm pomolino incluso.
- Glass mounted towel bar L-469 mm knob included
- Handtuchterhalter für Glass L-469 mm Knopf enthalten

IL - NO

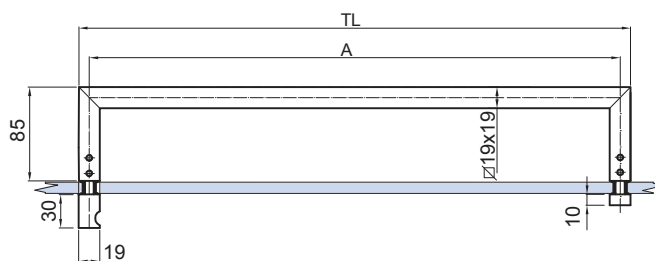
B-125

- Portasalvietta montato a vetro L-619 mm pomolino incluso.
- Glass mounted towel bar L-619 mm knob included
- Handtuchterhalter für Glass L-619 mm Knopf enthalten

IL - NO



☒	Code	A	TL	☒	Finitura Finishes Oberfläche	Materiale Material Material
	B-124	450	469	10	IL - NO	Inox Stainless steel Edelstahl
	B-125	600	619	10	IL - NO	Inox Stainless steel Edelstahl

PG-CHIAVE

- Chiave regolabile.
- Installation tool adjustable.
- Handwerkzeug Verstellbar.

 Foro vetro
Glass hole
Glasbohrung

IX
Acciaio inox satinato
Satin stainless steel
Edelstahl matt

CR
Cromo lucido
Polished chrome
Chrom glänzend

AN
Alluminio anodizzato
Aluminium anodized
Aluminium Silberfarbig

IL
Acciaio inox lucido
Polished stainless steel
Edelstahl poliert

NO
Nero opaco
Matt black
Schwarz matt