

POMOLI, NICCHIE, MANIGLIONI

KNOBBS, SLIDING HANDLES, HANDLES / KNÖPFE, GRIFFMUSCHELN, STOSSGRIFFE



B-196

- Coppia pomoli 25 x 28 mm.
 - Pair of doorknobs 25 x 28 mm.
 - Paar Türknöpfe 25 x 28 mm.
- CR - NS - NO - OR

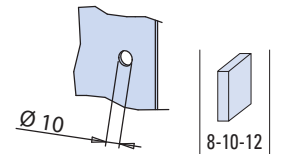
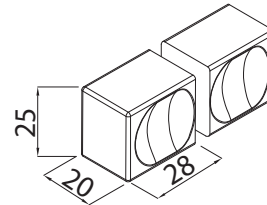

B-198

- Coppia pomoli 30 x 30 mm.
 - Pair of doorknobs 30 x 30 mm.
 - Paar Türknöpfe 30 x 30 mm.
- CR - NS - NO

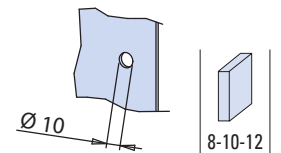
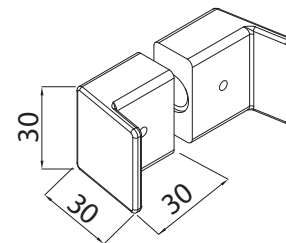
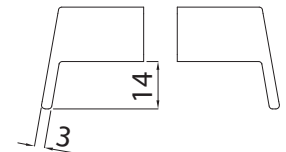

V-024 25

- Coppia pomoli Ø 25 mm.
 - Pair of doorknobs Ø 25 mm.
 - Paar Türknöpfe Ø 25 mm.
- CR - NS

V-024 30

- Coppia pomoli Ø 30 mm.
 - Pair of doorknobs Ø 30 mm.
 - Paar Türknöpfe Ø 30 mm.
- CR - NS - OR

V-024 32

- Coppia pomoli Ø 32 mm.
 - Pair of doorknobs Ø 32 mm.
 - Paar Türknöpfe Ø 32 mm.
- CR - NS

V-024 38

- Coppia pomoli Ø 38 mm.
 - Pair of doorknobs Ø 38 mm.
 - Paar Türknöpfe Ø 38 mm.
- CR - NS

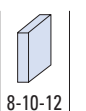
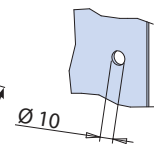
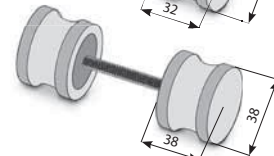
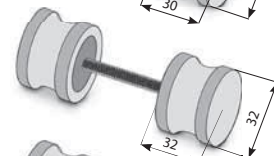
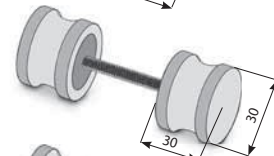
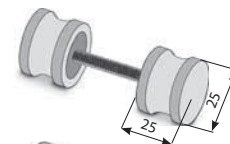

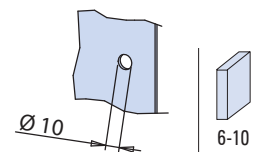
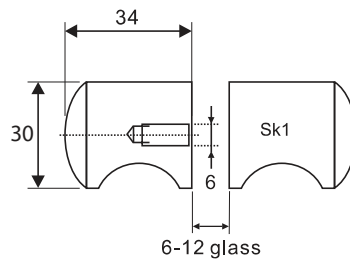

B-168

- Pomolo per porte in Zama.
 - Glass doors knob Zamak.
 - Paar Türknöpfe aus Zamak.
- CR - NS - CP - NO

B-169

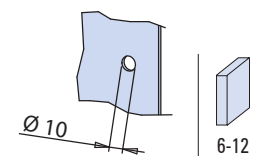
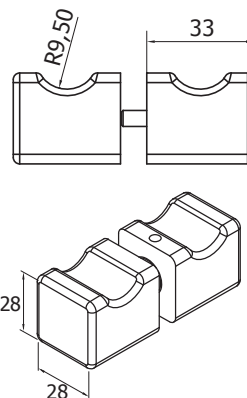
- Coppia pomoli 28 x 28 mm.
 - Pair of doorknobs 28 x 28 mm.
 - Paar Türknöpfe 28 x 28 mm.
- CR

V-1107

- Coppia pomoli 35 x 35 mm foro vetro Ø 10 mm
 - Pair of doorknobs 35 x 35 mm. Hole in glass 10 mm
 - Paar Türknöpfe 35 x 35 mm. Glas Bohrung 10 mm
- CR

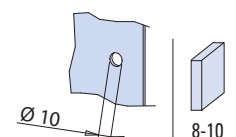

NS
Nickel satinato
Satin nickel
Ähnlich Edelstahl matt

CR
Cromo lucido
Polished chrome
Chrom glänzend

CS
Cromo satinato
Satin chrome
Chrom matt

CP
Cromo perla
Chrome perla similar Alu
Chrom perla ähnlich Alu

NO
Nero opaco
Matt black
Schwarz matt

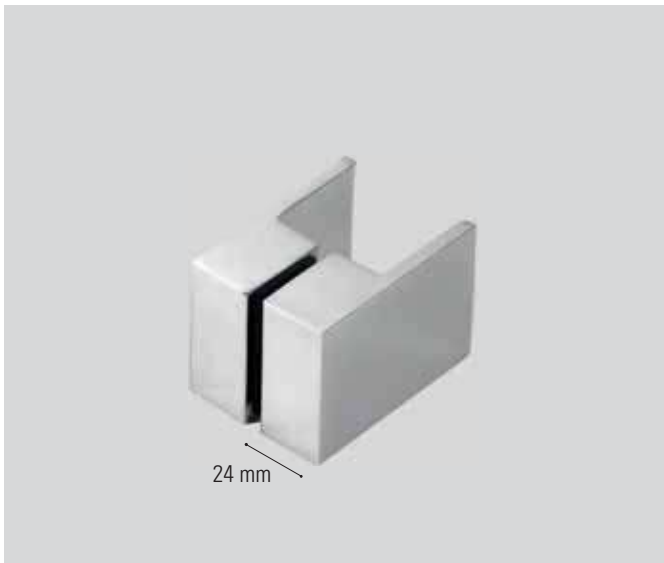

B-197

- Coppia pomoli 70 x 50 mm
 - Pair of doorknobs 70 x 50 mm
 - Paar Türknöpfe 70 x 50 mm
- CR

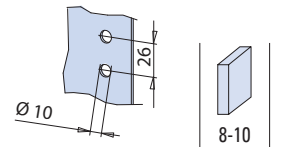

B-177

- Paio pomolini tondi d. 15
- Pair mini knobs d. 15
- Paar mini knöpfe d. 15

IL - IX

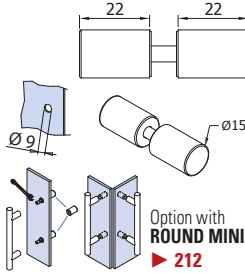

B-178

- Paio pomolini quadri q. 15
- Pair mini knobs q. 15
- Paar knöpfe mini q. 15

CR - NS

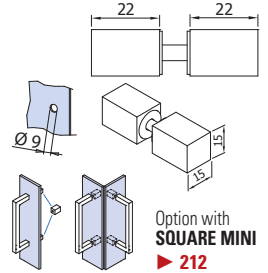

B-194

- Coppia pomoli Ø 32 mm
- Foro vetro Ø 10 mm
- Pair of doorknobs Ø 32 mm
- Hole in glass 10 mm
- Paar Türknöpfe Ø 32 mm
- Glas Bohrung 10 mm

CR - NS

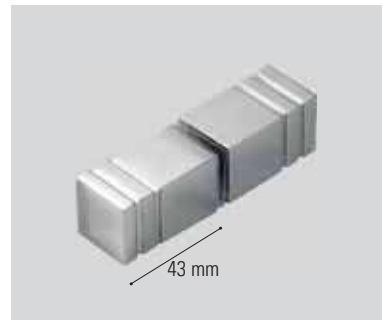
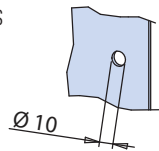

B-195

- Coppia pomoli 25x25 mm
- Foro vetro Ø 10 mm
- Pair of doorknobs 25x25 mm
- Hole in glass 10 mm
- Paar Türknöpfe 25x25 mm
- Glas Bohrung 10 mm

CR - NS

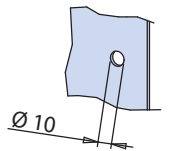

B-192

- Pomolo ad incollaggio biadesivo.
- Knob with self-adhesive fixing.
- Knopf selbstklebend.

CR

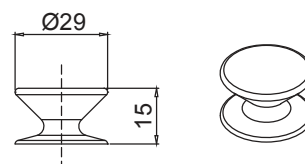



V-019

- Coppia pomoli in vetro.
 - Pair of door knobs in glass.
 - Paar Türknöpfe aus Glas.
- NS + GLASS

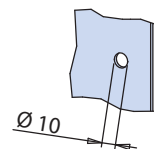

A = 40 / 45 / 50
S = 52 / 57 / 62



V-1056

- Coppia pomoli palla Ø 60 mm.
- Pair of door knobs Ø 60 mm.
- Paar Türknöpfe Ø 60 mm.

V-1056-2

- Coppia pomoli palla Ø 50 mm.
- Pair of door knobs Ø 50 mm.
- Paar Türknöpfe Ø 50 mm.

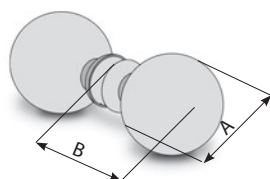
CS - NS - CR - OL - CP

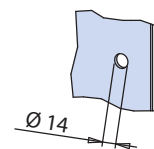

Ø 60 A = 60 / B = 78
Ø 50 A = 50 / B = 70

V-1105

- Coppia pomoli piatti Ø 55 mm.
- Pair of doorknobs Ø 55 mm.
- Paar Türknöpfe Ø 55 mm.

CS - NS - CR - OL - CP

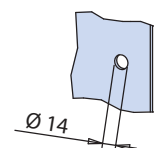
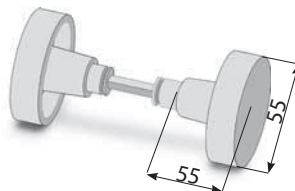
B-191-80 / B-191-240

- Maniglia ad incollaggio biadesivo.
- Small handle with self-adhesive fixing.
- Kleine griffe selbstklebend.

CR

		B-191-80	B-191-240
TL	80	•	
	240		•

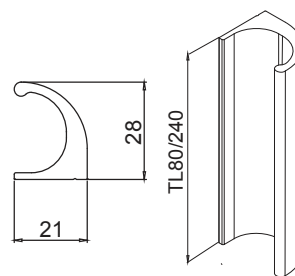

xme311

B-193

- Maniglia ad incollaggio biadesivo.
- Small handle with self-adhesive fixing.
- Kleine griffe selbstklebend.

CR

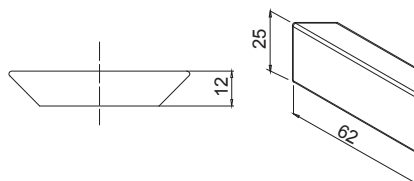

xme311

NS
Nickel satinato
Satin nickel
Ähnlich Edelstahl matt

CR
Cromo lucido
Polished chrome
Chrom glänzend

CS
Cromo satinato
Satin chrome
Chrom matt

OL
Ottone lucido
Polished brass
Messing poliert

CP
Cromo perla
Chrome perla similar Alu
Chrom perla ähnlich Alu