



WALL-D5603

COMPLETE SET WITH CLIP-ON PROFILES AND FRAMED SLIDING DOOR

KOMPLETTSET MIT KLIPSPROFIL UND GERAHMTE SCHIEBETÜR - SET COMPLETO DE PERFIL A CLIP Y PUERTAS DESLIZANTES ENMARCADAS - KIT COMPLET PORTE COULISSANTE PLUS PROFIL CLIPSABLE

Sliding system	DIV-5603	+ DIV-058	+ DIV-202	+ DIV-208 (optional)	+ DIV-204 (optional)
Max 	120 kg	Clip-on profile Klipsprofil Perfil a clip Profil a clipper	Finishing profile Abschlussprofil Perfil de acabado Profil de finition	H profile H Profil Perfil "H" Profil en H	Cross profile Querprofil Travesaño Traverse
Soft-close 	80 kg standard (100 /120 kg optional)				

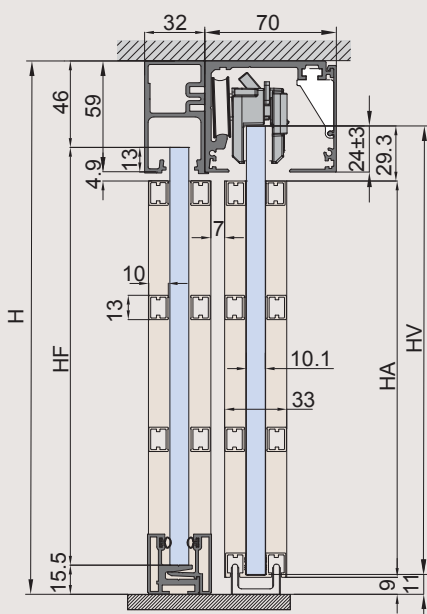
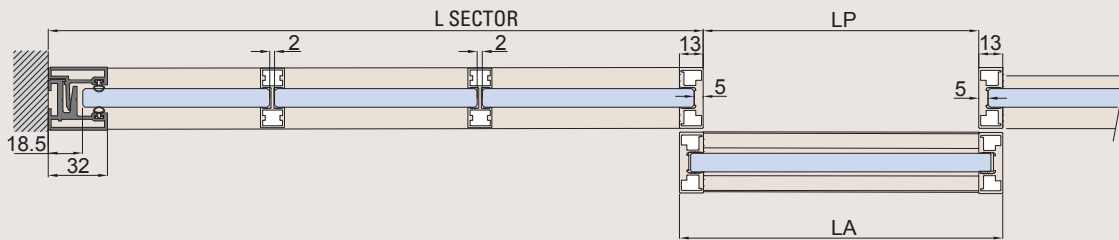
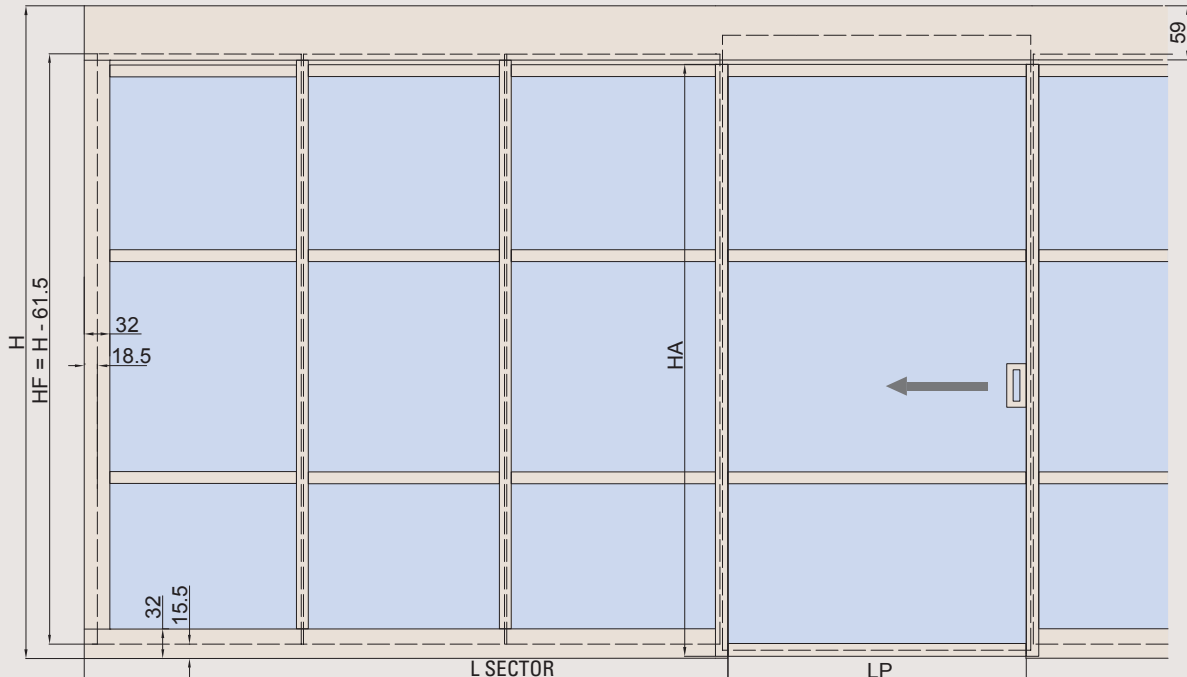

$$HV = H - 46$$

$$HF = H - 61.5$$

Framed door
Gerahmte Tür
Puerta enmarcada
Porte à cadre

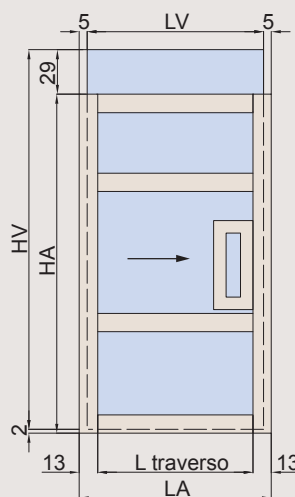

$$L \text{ horizontal profile} = LA - 26$$

$$L \text{ Horizontalprofil} = LA - 26$$

$$L \text{ perfil horizontal} = LA - 26$$

$$L \text{ profil horizontal} = LA - 26$$

$$LV = LP + 15$$

$$LA = LV + 10$$

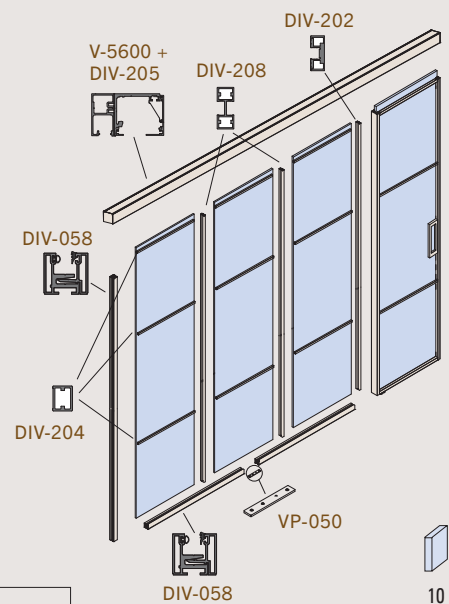

WALL-D7603

COMPLETE SET WITH CLIP-ON PROFILES AND FRAMED SLIDING DOOR

KOMPLETTSET MIT KLIPSPROFIL UND GERAHMTE SCHIEBETÜR - SET COMPLETO DE PERFIL A CLIP Y PUERTAS DESLIZANTES ENMARCADAS - KIT COMPLET PORTE COULISSANTE PLUS PROFIL CLIPSABLE

Sliding system DIV-7603	+ V-7606	+ DIV-202	+ DIV-208 (optional)	+ DIV-204 (optional)
Max  120 kg	(optional)	Finishing profile Abschlussprofil Perfil de acabado Profil de finition	H profile H Profil Perfil "H" Profil en H	Cross profile Querprofil Travesaño Traverse
Soft-close  80 kg standard (100 /120 kg optional)				

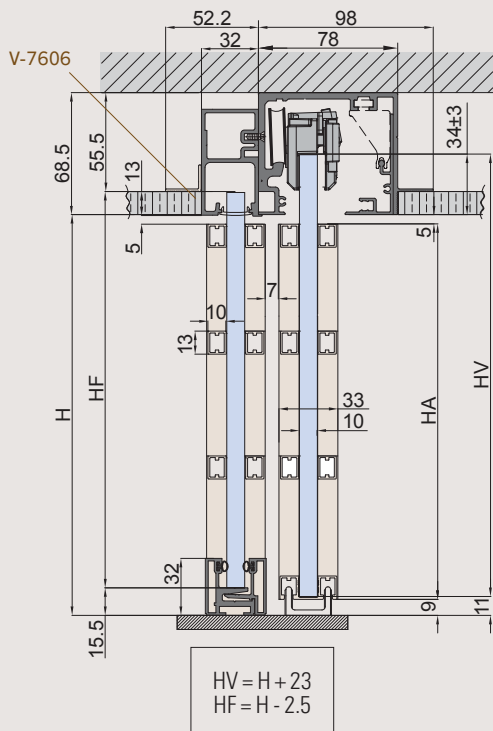
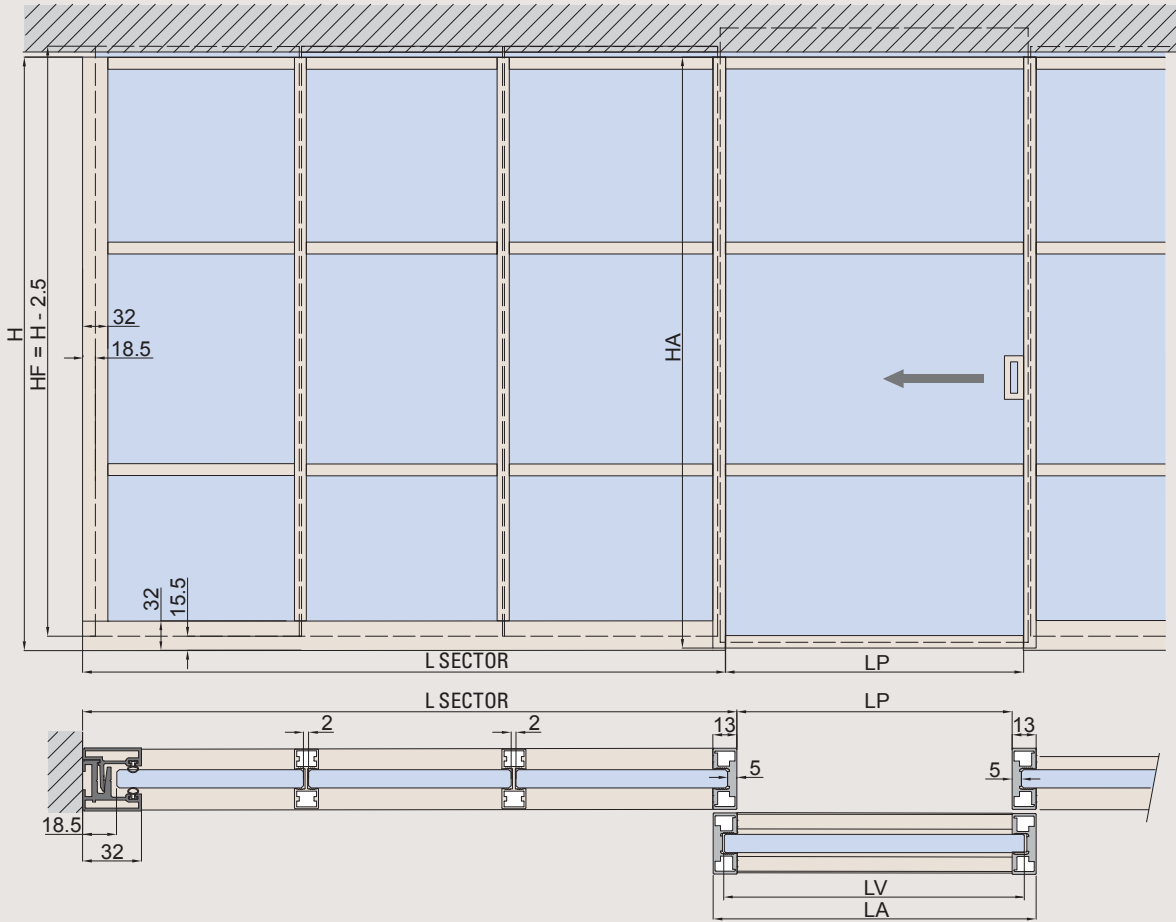

Framed door
Gerahmte Tür
Puerta enmarcada
Porte à cadre

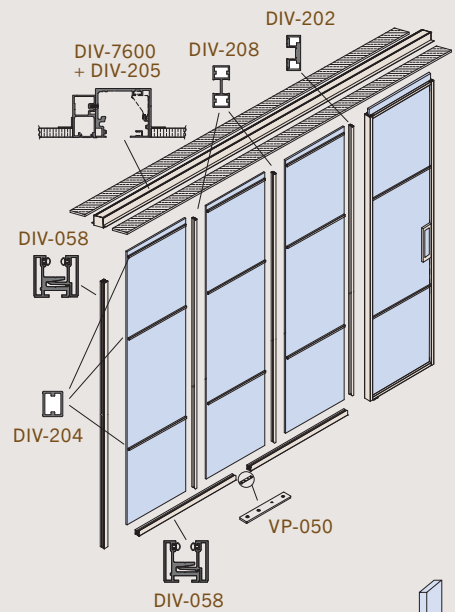
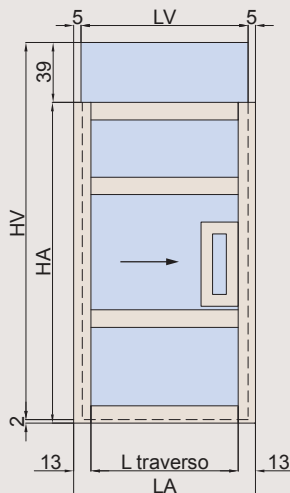

L horizontal profile = LA - 26
L Horizontalprofil = LA - 26
L perfil horizontal = LA - 26
L profil horizontal = LA - 26

LV = LP + 15
LA = LV + 10



xme620hg

FRAMED HINGED DOOR DIV

FRAMED SLIDING DOOR DIV - FORMULAS FOR CONFIGURATION OF THE CROSS PROFILES (V AND VL ARE VALUES ONLY FOR CALCULATION)
 GERAHMTE SCHIEBETÜR DIV - FORMELN FÜR KONFIGURATION VON QUERPROFILE (V UND VL SIND WERTE NUR FÜR DIE BERECHNUNG)
 PUERTA DESLIZANTE ENMARCADA- FORMULAS PARA CONFIGURACIÓN DE LISTONES (V Y VL SON LOS VALORES UNICAMENTE PARA EL CÁLCULO)
 PORTE COULISSANTE À CADRE DIV-100 FORMULE POUR LA CONFIGURATION DES TRAVERSES (V ET VL SONT DES VALEURS UNIQUEMENT POUR LE CALCUL)

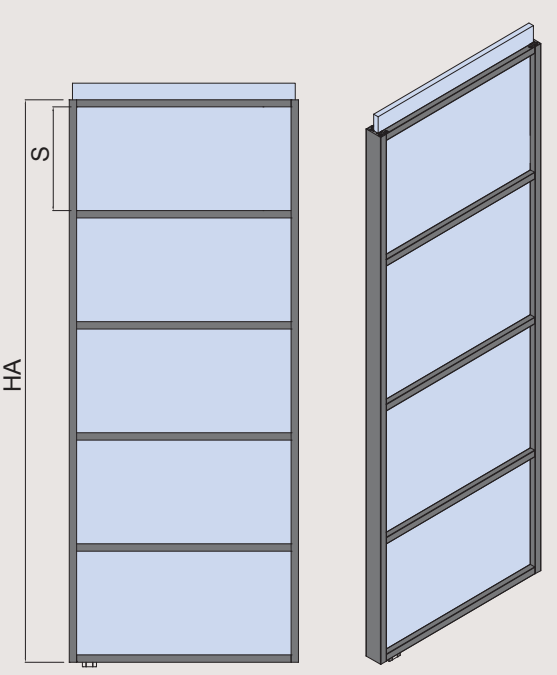

$$V = HA - (13 \times 6)$$

$$S = V / 5$$

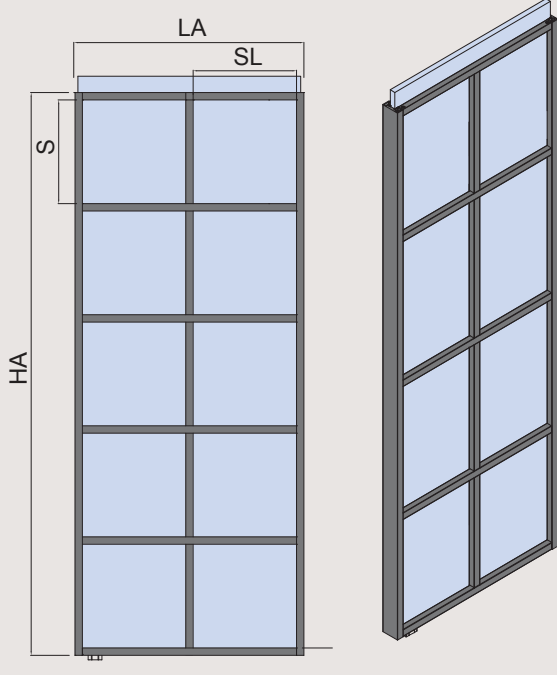

$$V = HA - (13 \times 6)$$

$$S = V / 5$$

$$VL = LA - 39$$

$$SL = VL / 2$$

MY METALGLAS

Configure your panel to calculate the cross profiles
Konfigurieren Sie Ihre Tür und berechnen Sie automatisch die Querprofile
Componga su puerta para cuantificar los travesaños por encargo
Composez votre porte pour quantifier les traverses à commander

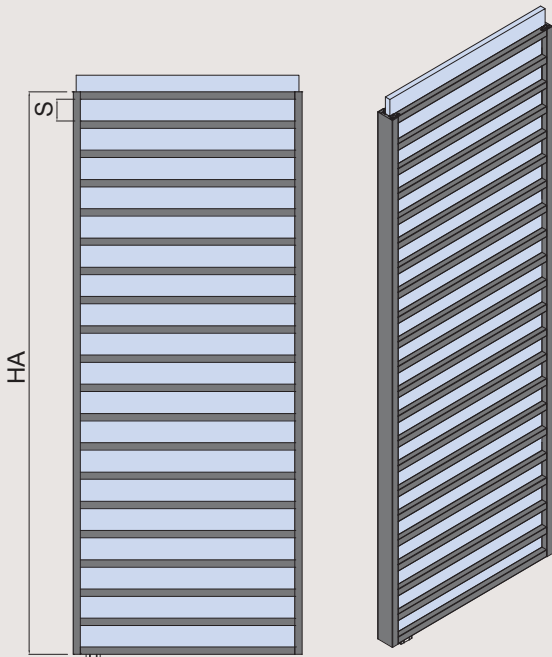

$$V = HA - (13 \times N)$$
$$S = V / (N - 1)$$

N = N° cross profiles - N° Querprofile - Número de transversales - N° de traverses

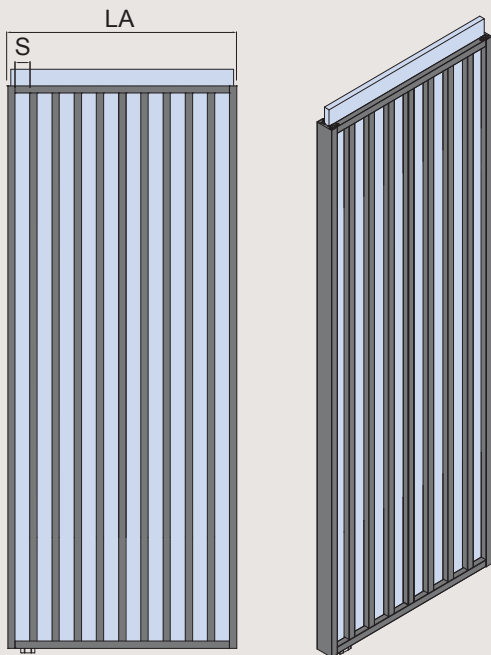

$$VL = LA - (13 \times N)$$
$$S = VL / (N - 1)$$

N = N° cross profiles - N° Querprofile - Número de transversales - N° de traverses

FRAMED DOOR

V and VL are values only for calculation - *V und VL sind Werte nur für die Berechnung*
 V o VL son trabajos que sirven solo para el cálculo - *V et VL sont des valeurs à des fins de calcul uniquement*

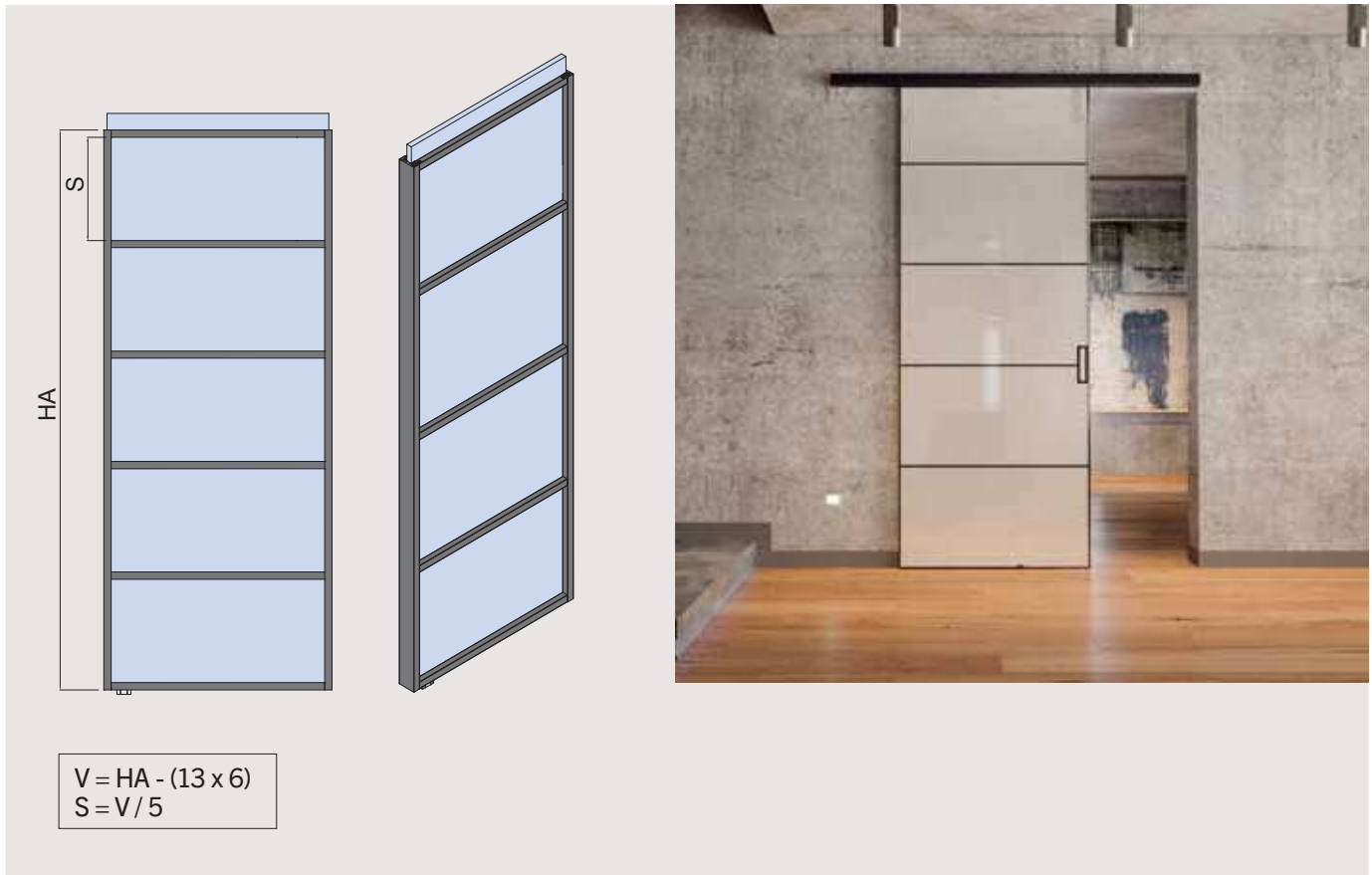

$$V = HA - (13 \times 6)$$

$$S = V / 5$$



$$V = HA - (13 \times 6)$$

$$S = V / 5$$

$$VL = LA - 39$$

$$SL = VL / 2$$

TECHNICAL PAGES

MY METALGLAS

Configure your panel to calculate the cross profiles
 Konfigurieren Sie Ihre Tür und berechnen Sie automatisch die Querprofile
 Componga su puerta para cuantificar los travesaños por encargo
 Composez votre porte pour quantifier les traverses à commander

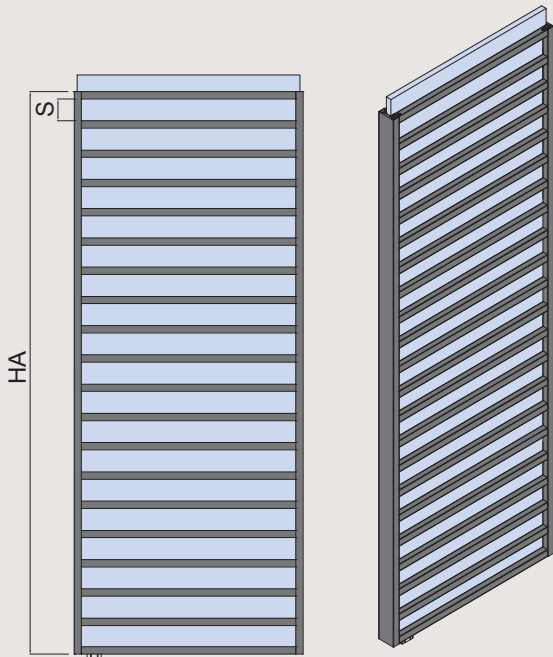

$$V = HA - (13 \times N)$$

$$S = V / (N - 1)$$

N = N° cross profiles - N° Querprofile - Número de transversales - N° de travese

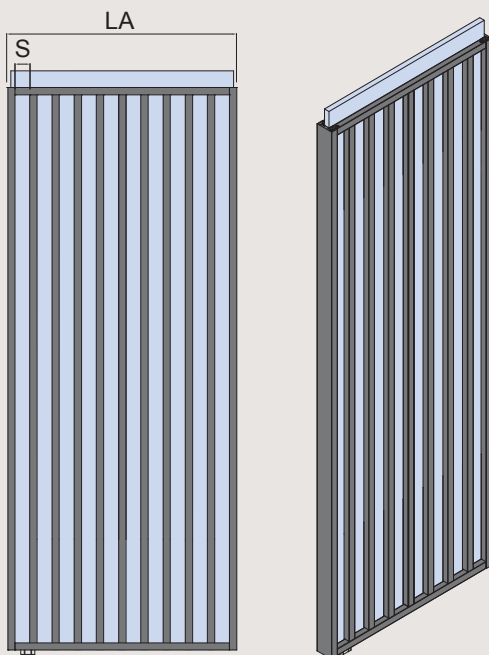

$$VL = LA - (13 \times N)$$

$$S = VL / (N - 1)$$

N = N° cross profiles - N° Querprofile - Número de transversales - N° de travese

MY METALGLAS

Configure your panel to calculate the cross profiles
 Konfigurieren Sie Ihre Tür und berechnen Sie automatisch die Querprofile
 Componga su puerta para cuantificar los travesaños por encargo
 Composez votre porte pour quantifier les traverses à commander