

# TECHNICAL PAGES

TECHNISCHE SEITEN  
PÁGINAS TÉCNICAS  
SECTION TECHNIQUE

## ACRONYM LEGEND

ERKLÄRUNG DER ABKÜRZUNGEN - LEYENDA - LEGENDE

|                |  |                   |   |
|----------------|--|-------------------|---|
| <b>LP</b>      | CLEAR OPENING WIDTH<br><i>LICHTE DURCHGANGSBREITE</i><br><i>ANCHO DE APERTURA LIBRE</i><br><i>LARGEUR D'OUVERTURE PASSAGE</i>  | <b>LB</b>         | RAIL LENGTH<br><i>LAUFSCHIENENLÄNGE</i><br><i>LONGITUD RIEL</i><br><i>LONGUEUR RAIL</i>   |
| <b>H / HP</b>  | CLEAR OPENING HEIGHT<br><i>LICHTE DURCHGANGSHÖHE</i><br><i>ALTURA DE APERTURA LIBRE</i><br><i>HAUTER D'OUVERTURE PASSAGE</i>   | <b>LV</b>         | GLASS WIDTH<br><i>GLAS BREITE</i><br><i>ANCHO DE VIDRIO</i><br><i>LARGEUR DE VERRE</i>  |
| <b>HM / HA</b> | SLIDING GLASS HEIGHT<br><i>SCHIEBEFLÜGEL HÖHE</i><br><i>ALTURA DE PANEL MÓVIL</i><br><i>HAUTEUR PANNEAU MOBILE</i>   | <b>HV</b>         | GLASS HEIGHT<br><i>GLAS HÖHE</i><br><i>ALTURA VIDRIO</i><br><i>HAUTEUR DU VERRE</i>   |
| <b>HF</b>      | SIDE FIXED GLASS HEIGHT<br><i>SEITENTEIL HÖHE</i><br><i>ALTURA DE PANEL FIJO</i><br><i>HAUTEUR PANNEAU FIXE</i>  | <b>LF</b>         | FIXED GLASS WIDTH<br><i>FESTGLASBREITE</i><br><i>ANCHO DE VIDRIO FIJO</i><br><i>LARGEUR DU VERRE FIXE</i>                                   |
| <b>HFA</b>     | VERTICAL PROFILE HEIGHT FIXED PANEL<br><i>VERTIKALPROFIL HÖHE SEITENTEIL</i><br><i>ALTURA DEL PERFIL VERTICAL PANEL FIJO</i><br><i>HAUTEUR DU PROFIL VERTICAL PANNEAU FIXE</i>                   | <b>L TRAVERSO</b> | HORIZONTAL PROFILE LENGTH<br><i>HORIZONTALPROFIL LÄNGE</i><br><i>LONGITUD DEL PERFIL HORIZONTAL</i><br><i>LONGUEUR DU PROFIL HORIZONTAL</i> |
| <b>HA</b>      | VERTICAL PROFILE HEIGHT MOVABLE PANEL<br><i>VERTIKALPROFIL HÖHE SCHIEBE- UND DREHFLÜGEL</i><br><i>ALTURA DEL PERFIL VERTICAL PANEL MÓVIL</i><br><i>HAUTEUR DU PROFIL VERTICAL PANNEAU MOBILE</i> | <b>HS</b>         | FRAME HEIGHT<br><i>ZARGE HÖHE</i><br><i>ALTURA DEL MARCO</i><br><i>HAUTEUR DU ENCADREMENT</i>   |
| <b>LM / LA</b> | MOVABLE DOOR WIDTH<br><i>SCHIEBE- UND DREHFLÜGEL BREITE</i><br><i>ANCHO DE PANEL MÓVIL</i><br><i>LARGEUR PANNEAU MOBILE</i>  | <b>LS</b>         | FRAME WIDTH<br><i>ZARGE BREITE</i><br><i>ANCHO DEL MARCO</i><br><i>LARGEUR DU ENCADREMENT</i>   |
| <b>LAF</b>     | FIXED GLASS WIDTH<br><i>SEITENTEIL BREITE</i><br><i>ANCHO DE PANEL FIJO</i><br><i>LARGEUR PANNEAU FIXE</i>   | <b>LMP</b>        | DOOR MODULE<br><i>TÜRMODULE</i><br><i>MÓDULO DE PUERTA</i><br><i>MODULE DE PORTE</i>  |

# WALL2-DIV100

COMPLETE SET WITH CLIP-ON PROFILE, DOOR JAMB AND FRAMED HINGED DOOR

KOMPLETTSET MIT KLIPSPROFIL, ZARGE UND GERAHMTE DREHTÜR - SET COMPLETO DE PERFIL A CLIP, JAMBA Y PUERTA BATIENTE - KIT COMPLET AVEC PROFIL A CLIPSEUR, CADRE DE PORTE AVEC PAUMELLES

|   |  |   |  |  |  |
|---|--|---|--|--|--|
| <b>SET = TP-150</b>                                       | <b>+ DIV-100</b>   | <b>+ DIV-050</b>  | <b>+ DIV-052</b>   | <b>+ DIV-208 (optional)</b>                        | <b>+ DIV-204 (optional)</b>                          |
| Door jamb<br>Zarge<br>Jamba de puerta<br>Montant de porte | Hinged framed panel<br>Gerahmte Dreh-Tür<br>Panel batiente enmarcado<br>Cadre avec paumelles | Clip-on profile<br>Klipsprofil<br>Perfil a clip<br>Profil a clipser | Top "U" channel<br>Oberes "U" Profil<br>Perfil "U" superior<br>Profil supérieur en U | H profile<br>H Profil<br>Perfil "H"<br>Profil en H | Cross profile<br>Querprofil<br>Travesaño<br>Traverse |

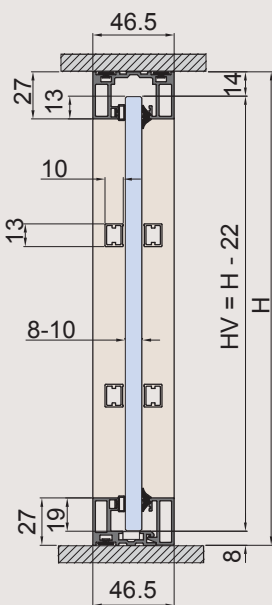
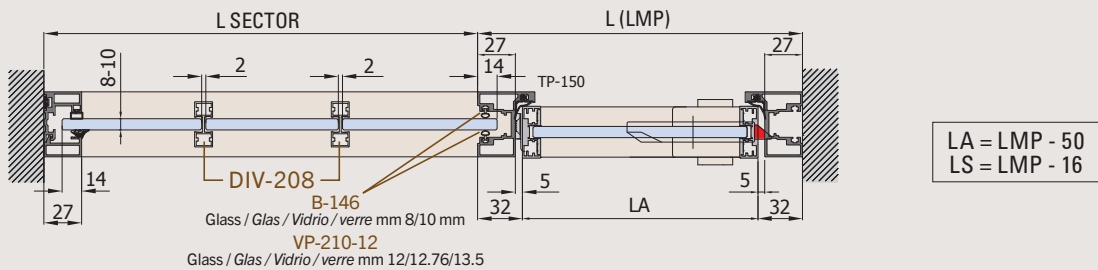
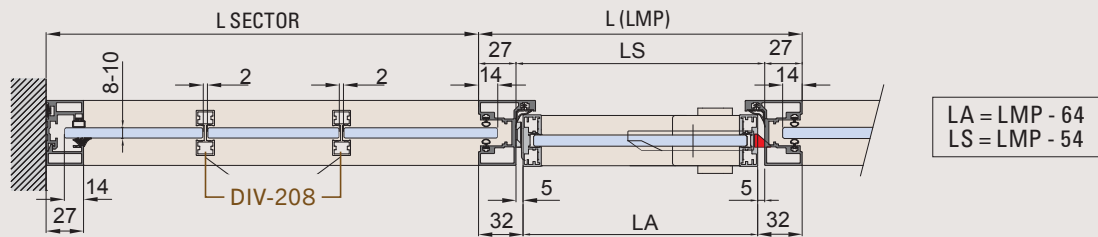
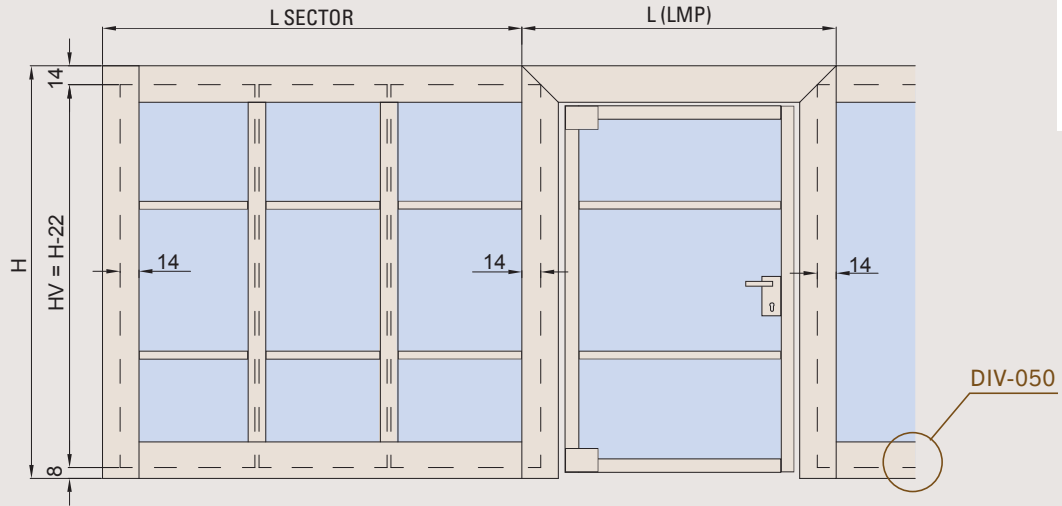

HV = H - 22

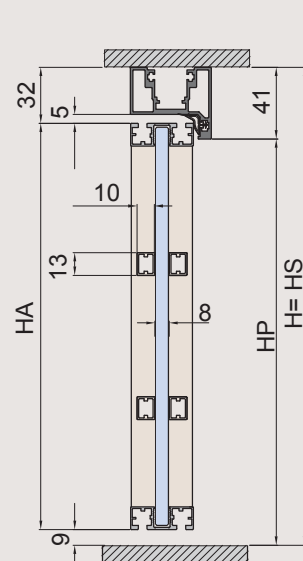

HA = H - 41

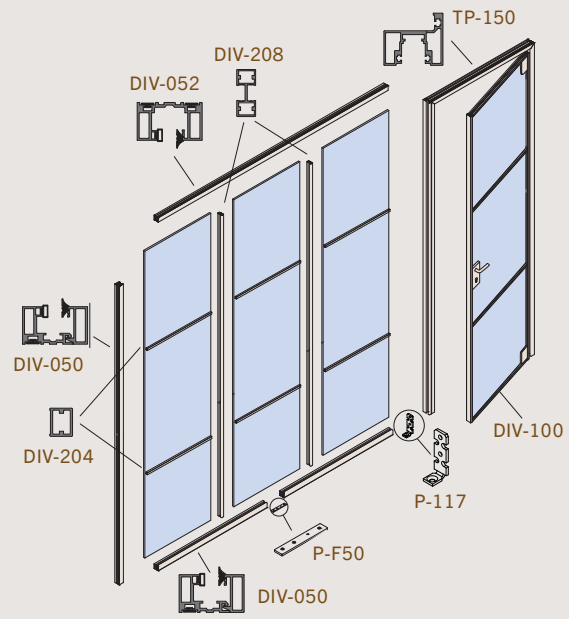

8 (Door / Tür / Puerta / Porte) 8/10 (Fixed glass / Festverglasung / Vidrio fijo / Verre fixe)

xme658c

# DIV-050 + DIV-052

PROFILES FOR FIXED PANELS - PROFILE FÜR FESTVERGLASUNGEN  
 PERFILES PARA VIDRIOS FIJOS - PROFIL CLIPSABLE POUR PANNEAU FIXE



MY METALGLAS

Configure your panel to calculate the cross profiles  
 Konfigurieren Sie Ihre Tür und berechnen Sie automatisch  
 die Querprofile  
 Componga su puerta para cuantificar los travesaños por encargo  
 Composez votre porte pour quantifier les traverses à commander



**DIV-050**  
 Clip-on profile for fixed panel  
 Klipsprofil für Festverglasung  
 Perfil de clip  
 Profil clipsable pour panneau fixe

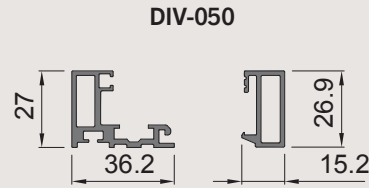

**DIV-052**

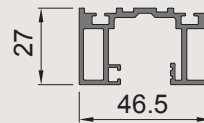

**DIV-052**  
 Top "U" channel  
 Oberes "U" Profil  
 Perfil "U" superior  
 Profil supérieur en U

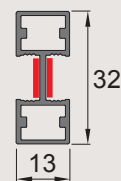
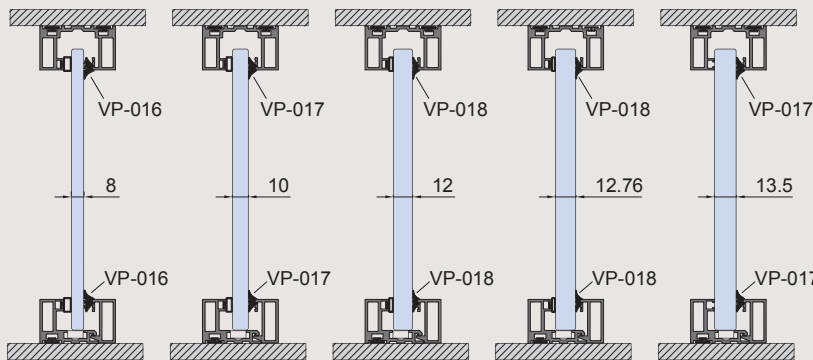
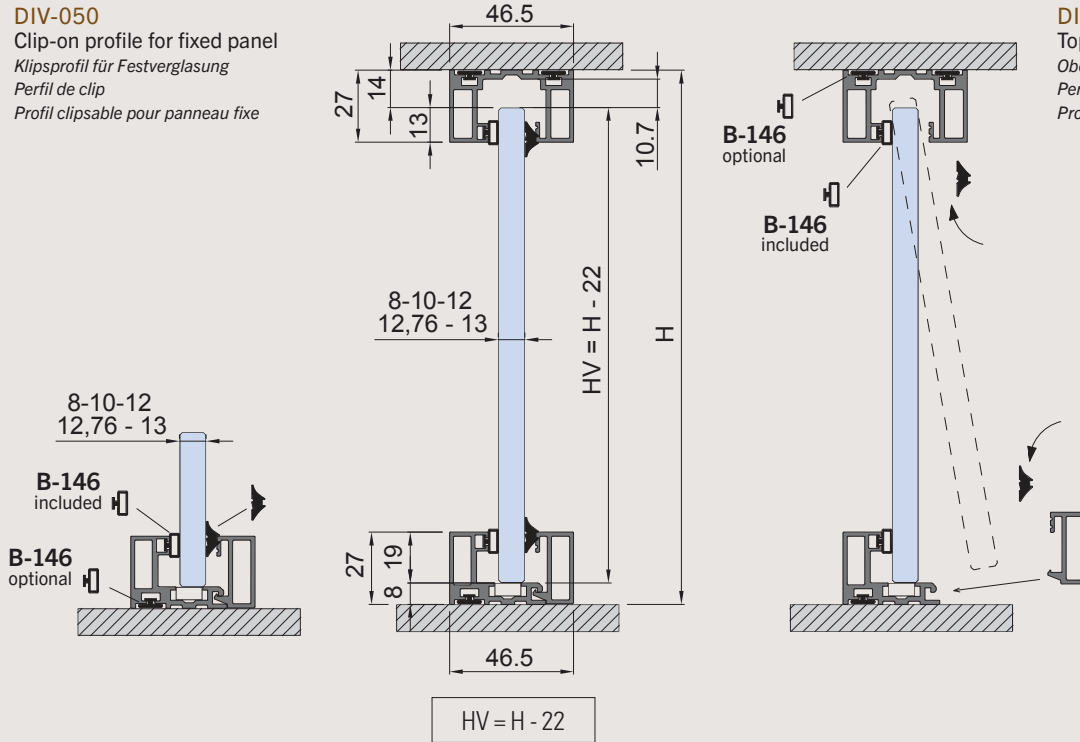

**DIV-208**  
 "H" profile Glass-Glass  
 "H" Profil Glas-Glas  
 Perfil "H" vidrio - vidrio  
 "H" profil verre verre

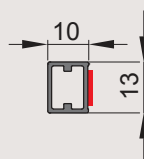

**DIV-204**  
 Cross profile  
 Querprofil  
 Travesaño  
 Traverse



**P-117**

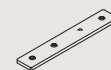

**P-F50**

# DIV-100



HINGED FRAMED PANEL

GERAHMTE DREHTÜR - PANEL DE PUERTA BATIENTE ENMARCADA - CADRE AVEC PAUMELLES

Door / Tür / Puerta / Porte **DIV-100**

Max 

55 kg

 8  
 950 max



## DIV-100

Framed panel set max 950 x 2980 mm (lock not included)

Gerahmte Drehtür-Set max 950 x 2980 mm (Schloss nicht enthalten)

Set de puerta enmarcada, max 950 x 2980 mm (cerradura no incluida)

Kit cadre avec paumelles max 950 mm x 2980 mm (serrure en option)

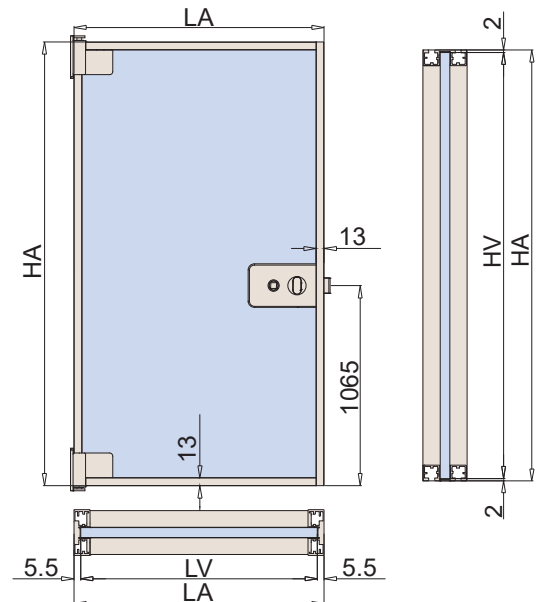

$$LV = LA - 11$$

$$HV = HA - 4$$

V-741 PZ / MV-741 PZ   
Vertical lock  
Vertikales schloss  
Cerradura vertical  
Serrure verticale

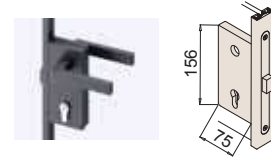

V-740 UV / MV-740 UV   
Compacted lock  
Kompaktes Schloss UV  
Cerradura compacta  
Serrure compacte



V-740 WC / MV-740 WC   
Horizontal lock WC  
Horizontalschloss WC  
Cerradura horizontal WC  
Serrure horizontale WC



DIV-M101  
Magnetic small handle  
Kleine Magnetgriffe  
Manilla compacta magnética  
Petite poignée aimantée

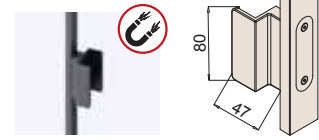

xme636a/g/u

DIV-V742  
Pair hinges  
Paar Bänder  
Par de bisagras  
Paire de paumelles

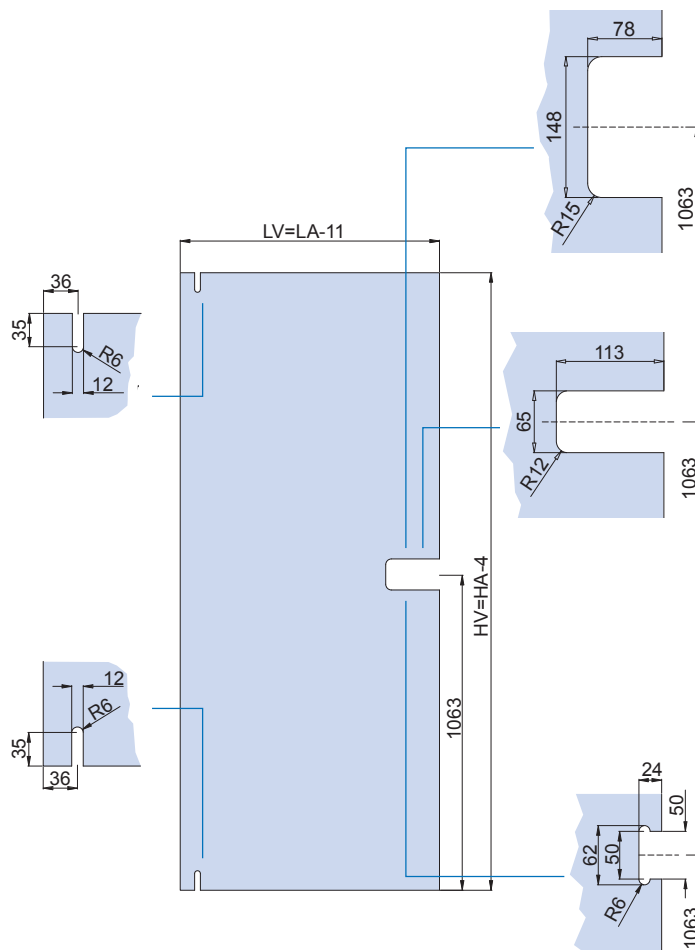
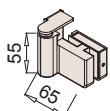

# STIPITI P-030/TP-150

DOOR JAMBS FOR FRAMED HINGED DOOR

ZARGEN FÜR GERAHMTE DREHTÜR - JAMBAS DE PUERTA PARA PUERTAS BATIENTES ENMARCADAS - ENCADREMENT POUR PORTE À CADRE



**P-030/P-031**  
Door jamb / Zarge - Jamba de puerta - Encadrement



**P-012-CF4**

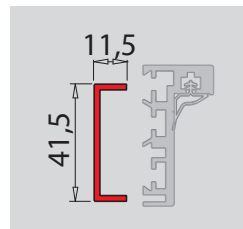

Optional wall profile for adjustment P-033  
Wandprofil für Verstellung P-033  
Perfil a muro para regulación P-033 opcional  
Profil d'alignement mural P-033 en option

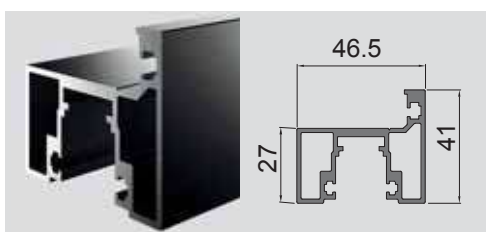

**TP-150**  
Door jamb / Zarge - Jamba de puerta - Encadrement

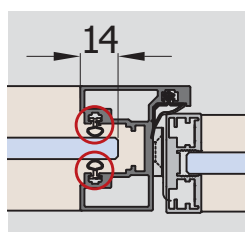

**B-146**  
Glass gaskets mm 8/10 mm  
Glasdichtungen mm 8/10 mm  
Guarnición mm 8/10  
Joint pour verre de 8/10 mm

**VP-210-12**  
Glass gaskets mm 12/12.76/13.5  
Glasdichtungen mm 12/12.76/13.5  
Guarnición mm 12/12.76/13.5  
Joint pour verre de 12/12,76/13,5



# FRAMED HINGED DOOR DIV-100

FRAMED SLIDING DOOR DIV - FORMULAS FOR CONFIGURATION OF THE CROSS PROFILES (V AND VL ARE VALUES ONLY FOR CALCULATION)  
 GERAHMTE SCHIEBETÜR DIV - FORMELN FÜR KONFIGURATION VON QUERPROFILE (V UND VL SIND WERTE NUR FÜR DIE BERECHNUNG)  
 PUERTA DESLIZANTE ENMARCADA - FORMULAS PARA CONFIGURACIÓN DE LISTONES (V Y VL SON LOS VALORES UNICAMENTE PARA EL CÁLCULO)  
 PORTE A CADRE SUR PAUMELLES DIV-100 FORMULE POUR LA CONFIGURATION DES TRAVERSES (V ET VL SONT DES VALEURS UNIQUEMENT POUR LE CALCUL)

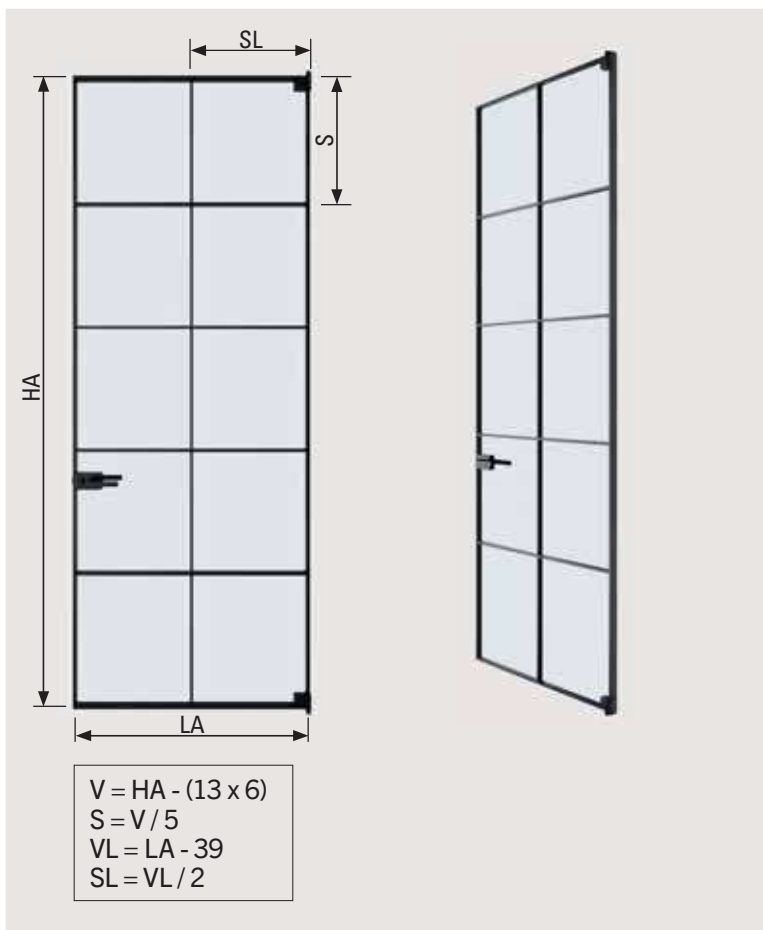
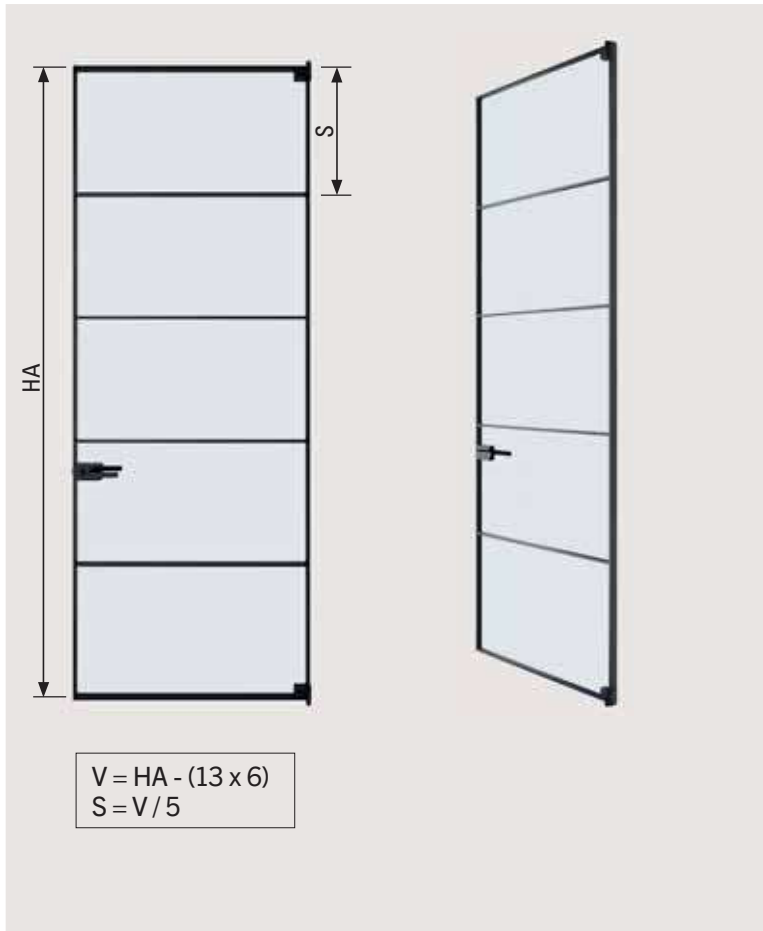

TECHNICAL PAGES

## MY METALGLAS

Configure your panel to calculate the cross profiles  
Konfigurieren Sie Ihre Tür und berechnen Sie automatisch die Querprofile  
Componga su puerta para cuantificar los travesaños por encargo  
Composez votre porte pour quantifier les traverses à commander

