

# PA-600 FORTI SPESSORI

SCORREVOLI A PARCHEGGIO / SLIDING STACKING SYSTEMS / GANZGLAS-SCHIEBEWANDSYSTEME

**MY METALGLAS**

SCORREVOLI A PARCHEGGIO  
SLIDING STACKING SYSTEMS



- Sistema scorrevole a parcheggio fornito con profili fermavetro su misura richiesta dal cliente, senza necessità di fori nel vetro.
- Sliding stacking system with glass fixing profiles made to measure upon client's request, no need to make holes in the glass.
- Schiebesystem mit Parkraum, kundenspezifische Glasleistenprofile ohne Glasbohrungen.

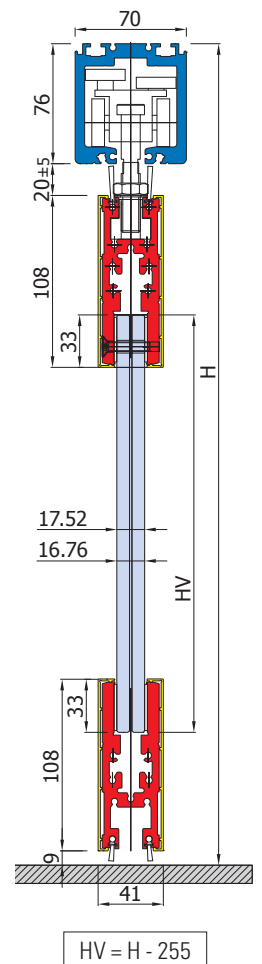

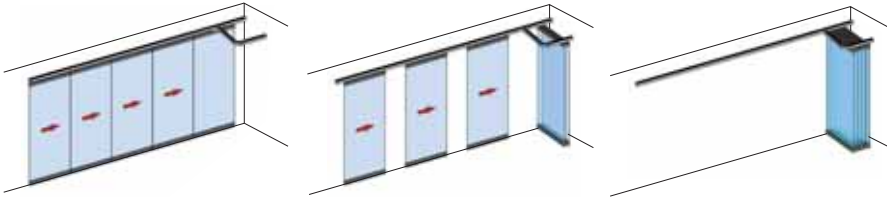

 16,76 17,52	 150 Kg	 110 Kg	 550 min 1000 max 3500
--------------------	------------	------------	---------------------------------

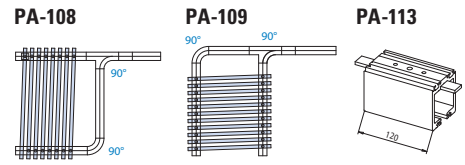
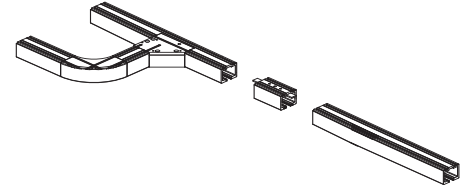
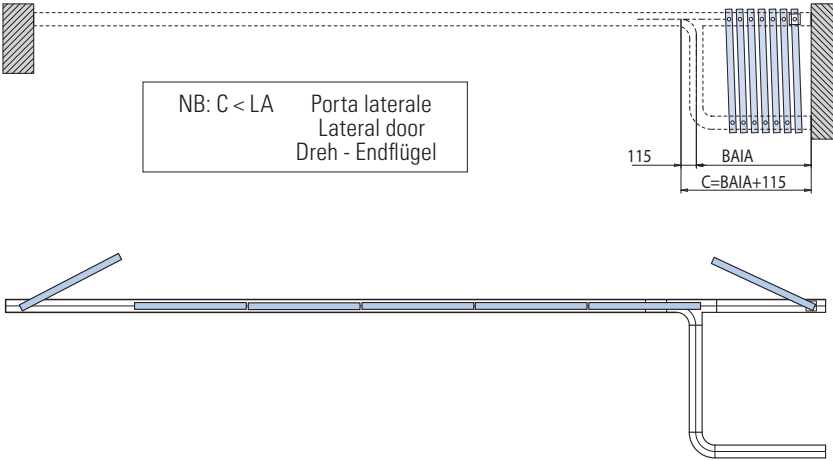

- Da ordinare a parte oltre alle ante
- To be ordered separately from the panels
- Neben den Flügeln extra zu bestellen

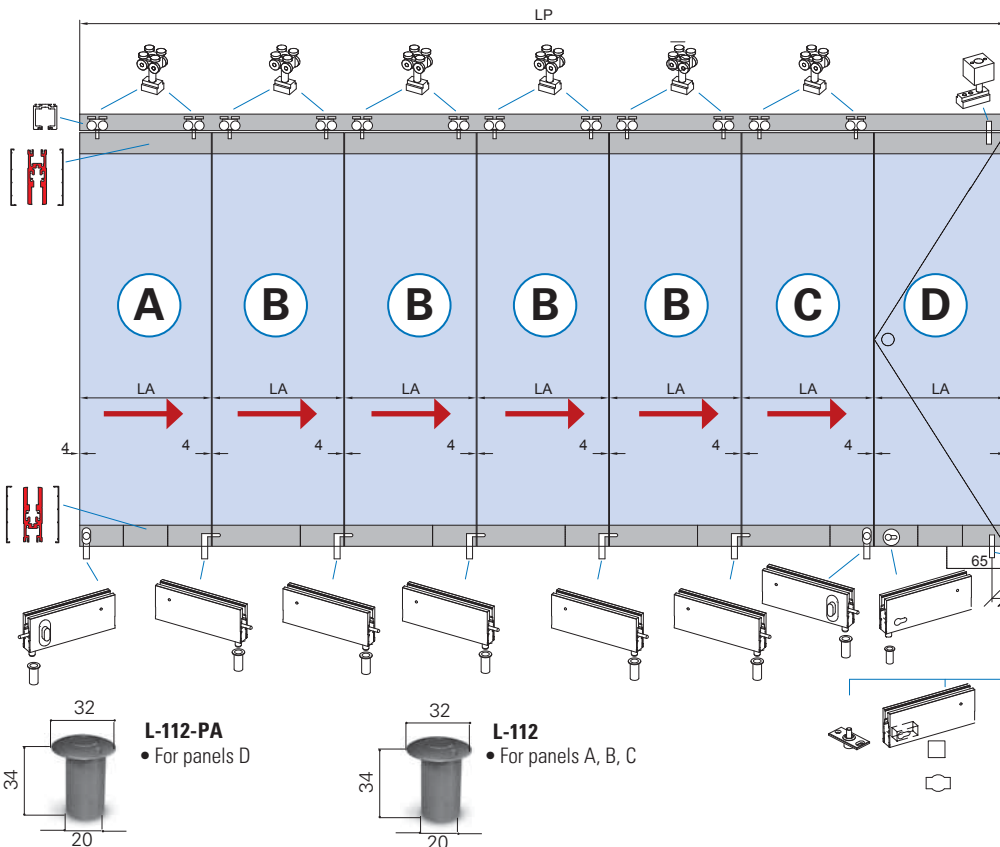
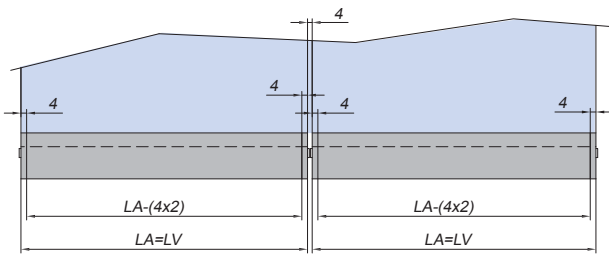

- Calcolo vetro
- Calculation glass
- Glasberechnung

$$At = 4 \times (N + 1)$$

$$X = LP - At$$

$$LA = LV = X / N$$

- (A)**
  - Prima anta
  - First panel
  - Erster Schiebeflügel
- (B)**
  - Anta intermedia
  - Intermediate panel
  - Zwischen-Schiebeflügel
- (C)**
  - Ultima anta
  - Last panel
  - End-Schiebeflügel
- (D)**
  - Porta laterale
  - Lateral pivot door
  - Dreh-Endflügel

xme527b / xme527f

AN	At	N	LP	LA = LV	H	HV	HA
Alluminio anodizzato Aluminium anodized Aluminium Silberfarbig	Arie totali Total clearances Summe alle Abstände Glas/Wand	Numero ante Numbers panels Anzahl der Elemente	Passaggio luce Clear opening width Lichte Durchgangsbreite	Larghezza ante = Larghezza vetro Panel width = Glass width Flügelbreite = Glasbreite	Altezza passaggio luce Clear opening height Lichte durchgangshöhe	Altezza vetro Glass height Glashöhe	Altezza anta Door height Tür Höhe

# PA-600 FORTI SPESSORI

COME USARE MY METALGLAS / HOW TO USE MY METALGLAS / WIE MAN BENUTZT MY METALGLAS

**1** INSERIRE LE MISURE DEL TUO VANO E LE ANTE DESIDERATE  
ENTER THE MEASUREMENTS OF YOUR OPENING AND THE DOORS YOU REQUIRE  
GEBEN SIE DIE MASSE IHRER ÖFFNUNG EIN UND DIE ERFORDERLICHEN TÜREN

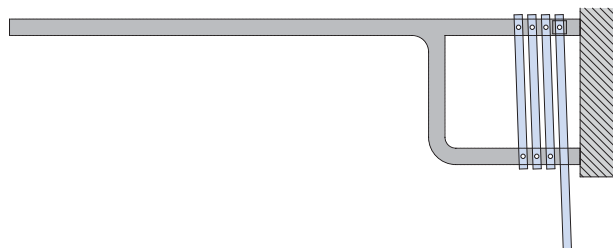
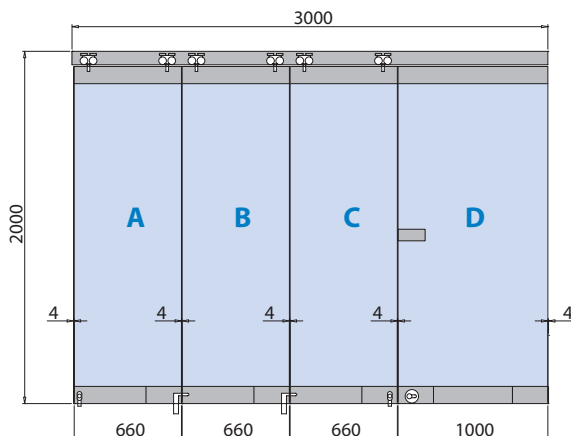

**2** SI OTTENGONO LE MISURE DEI VETRI AUTOMATICAMENTE  
THE MEASUREMENTS OF THE GLASS WILL BE GENERATED AUTOMATICALLY  
DIE ABMESSUNGEN DES GLASES WERDEN AUTOMATISCH BERECHNET

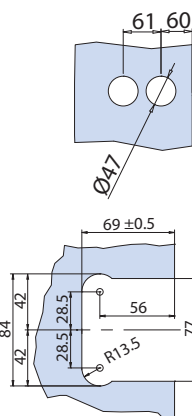
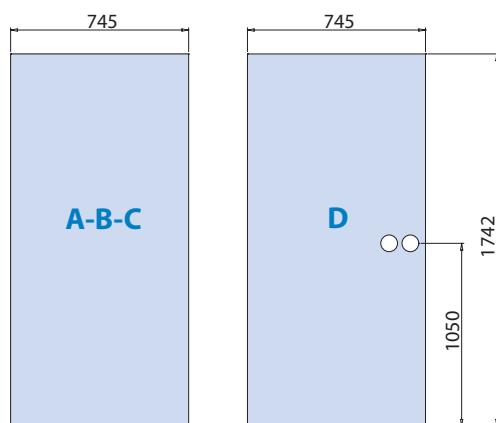

- Foratura vetro porta battente per serrature optional
- Glass preparation pivot door for optional locks
- Glasbearbeitung Dreh-Flügel für optionale Schlösser

- Foratura vetro porta battente per serrature optional V-504, V-505, V-518, V-519, V-520
- Glass preparation pivot door for optional locks V-504, V-505, V-518, V-519, V-520
- Glasbearbeitung Dreh-Flügel für optionale Schlösser V-504, V-505, V-518, V-519, V-520

**3** SI OTTENGONO LE DISTINTE DI TAGLIO DEI PROFILI, DA ABBINARE AGLI ACCESSORI  
THE CUTTING SPECIFICATIONS OF THE PROFILES ARE OBTAINED, FOR MATCHING WITH THE ACCESSORIES  
SIE ERHALTEN EINE SPEZIFIKATION DER PROFILLÄNGEN ZUM ABGLEICHEN MIT DEM ZUBEHÖR

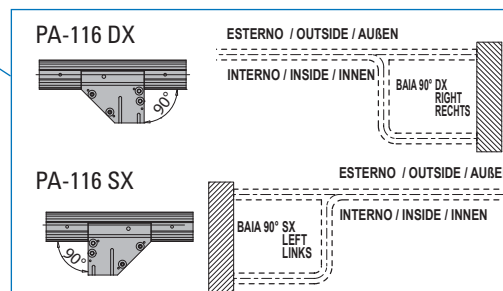
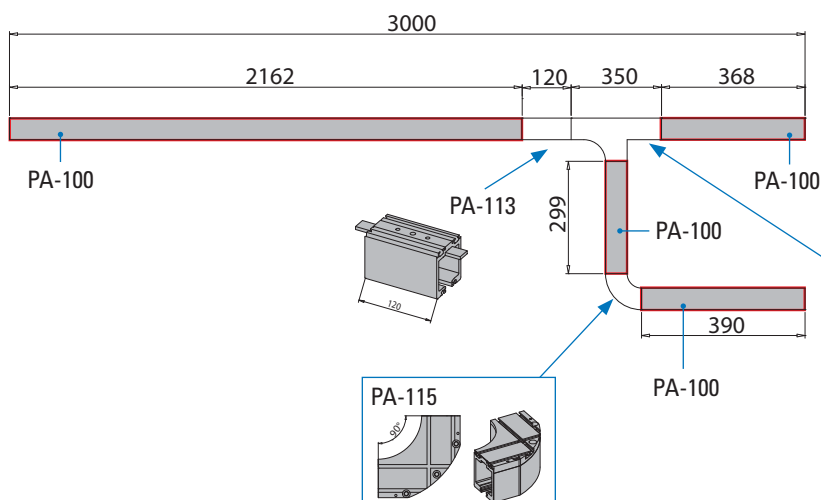

# PA-600 FORTI SPESSORI

## COME ASSEMBLARE LE ANTE / HOW TO ASSEMBLE THE DOORS / WIE DIE TÜREN ZUSAMMENSETZT WERDEN

TAGLIO PROFILI  
PROFIL PREPARATION / PROFILBEARBEITUNG

+

KIT ACCESSORI  
ACCESSORY SETS / ZUBEHÖR SETS

=

ANTA COMPLETA  
COMPLETE DOOR / KOMPLETTE TÜR

**ANTA A / DOOR A / TÜRA**

**SUPERIORE / TOP / OBEN**

**INFERIORE / BOTTOM / UNTEN**

- Lavorazione veletta con PA-625 + PA-203-POM
- Cover profile preparation with PA-625 + PA-203-POM
- Vorbereitung der Abdeckung mit PA-625 + PA-203-POM

**PA-600 ANTA A-16** (for glass 16,76 mm)  
**PA-600 ANTA A-17** (for glass 17,52 mm)  
PRIMA ANTA A  
FIRST PANEL A  
RSTER SCHIEBEFLÜGEL A

**ANTA B / DOOR B / TÜRB**

**SUPERIORE / TOP / OBEN**

**INFERIORE / BOTTOM / UNTEN**

**PA-600 ANTA B-16** (for glass 16,76 mm)  
**PA-600 ANTA B-17** (for glass 17,52 mm)  
ANTA INTERMEDIA B  
INTERMEDIATE PANEL B  
ZWISCHEN-SCHIEBEFLÜGEL B

**ANTA C / DOOR C / TÜRC**

**SUPERIORE / TOP / OBEN**

**INFERIORE / BOTTOM / UNTEN**

- Lavorazione veletta con PA-625 + PA-203-POM
- Cover profile preparation with PA-625 + PA-203-POM
- Vorbereitung der Abdeckung mit PA-625 + PA-203-POM

**PA-600 ANTA C-16** (for glass 16,76 mm)  
**PA-600 ANTA C-17** (for glass 17,52 mm)  
ULTIMA ANTA C  
LAST PANEL C  
END-SCHIEBEFLÜGEL C

 SCORREVOLI A PARCHEGGIO  
SLIDING STACKING SYSTEMS



# PA-600 FORTI SPESSORI

## COME ASSEMBLARE LE ANTE / HOW TO ASSEMBLE THE DOORS / WIE DIE TÜREN ZUSAMMENSETZT WERDEN

TAGLIO PROFILI  
PROFIL PREPARATION / PROFILBEARBEITUNG



KIT ACCESSORI  
ACCESSORY SETS / ZUBEHÖR SETS



ANTA COMPLETA  
COMPLETE DOOR / KOMPLETTE TÜR

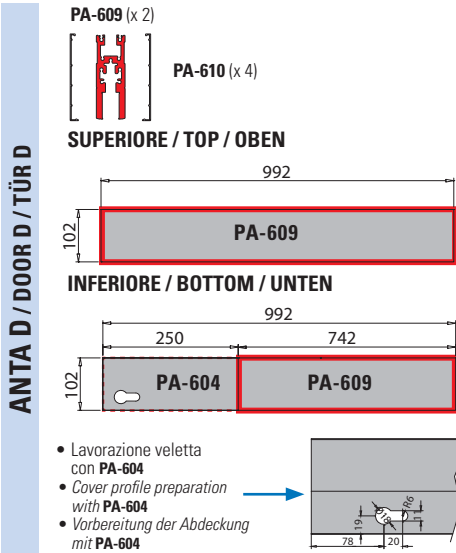

**PA-600 ANTA D-16** (for glass 16,76 mm)  
**PA-600 ANTA D-17** (for glass 17,52 mm)  
PORTA LATERALE D  
LATERAL PIVOT DOOR D / DREH-SCHIEBEFLÜGEL D

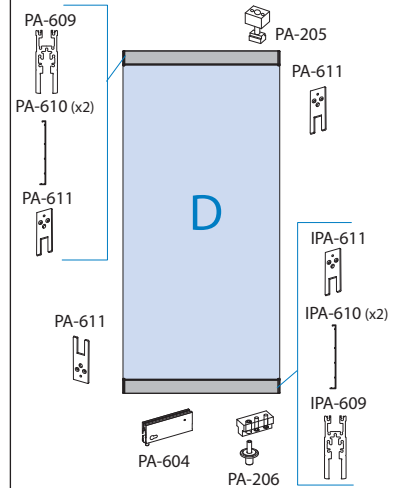

SCORREVOLI A PARCHEGGIO  
SLIDING STACKING SYSTEMS



