

BRIXIA TELESCOPICO



MY METALGLAS

Componi la tua anta per quantificare i traversini da ordinare
 Configure your panel to calculate the cross profiles
 Konfigurieren Sie Ihre Tür und berechnen Sie automatisch die Querprofile

Sliding system	V-1330 SYNCHRO	V-1380 MECH
Max	100 kg	100 kg
Soft-close	80 kg (optional)	80 kg (optional)

8/10		8.76/10.76/12 con-with-mit V-1817		520 min 1000 max		V-1224 OPTIONAL SOFT-CLOSE	
				700 min 1 pc	970 min 2 pcs		

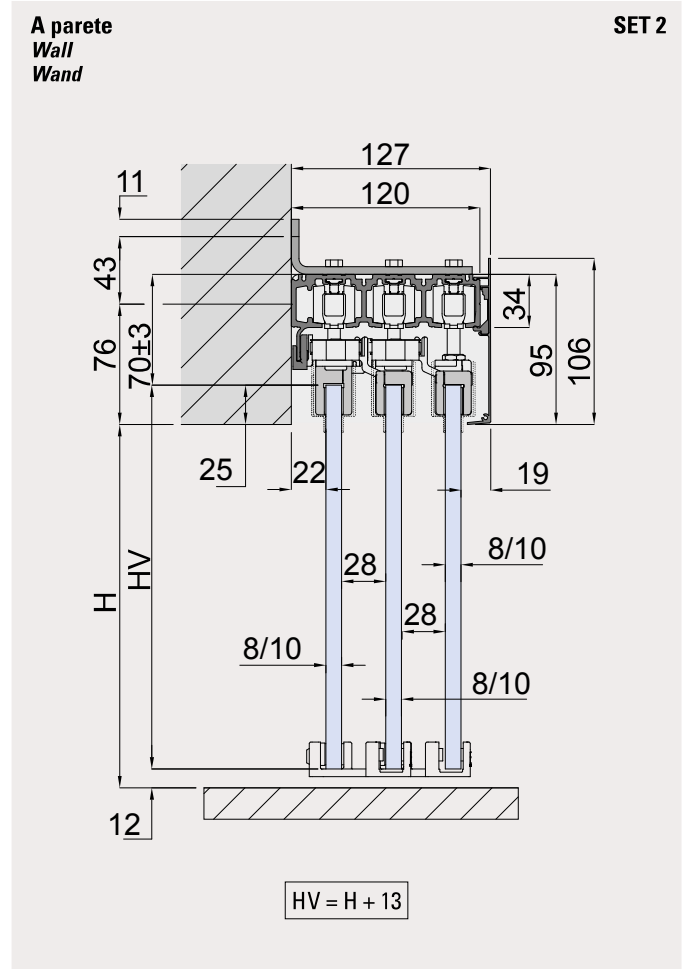
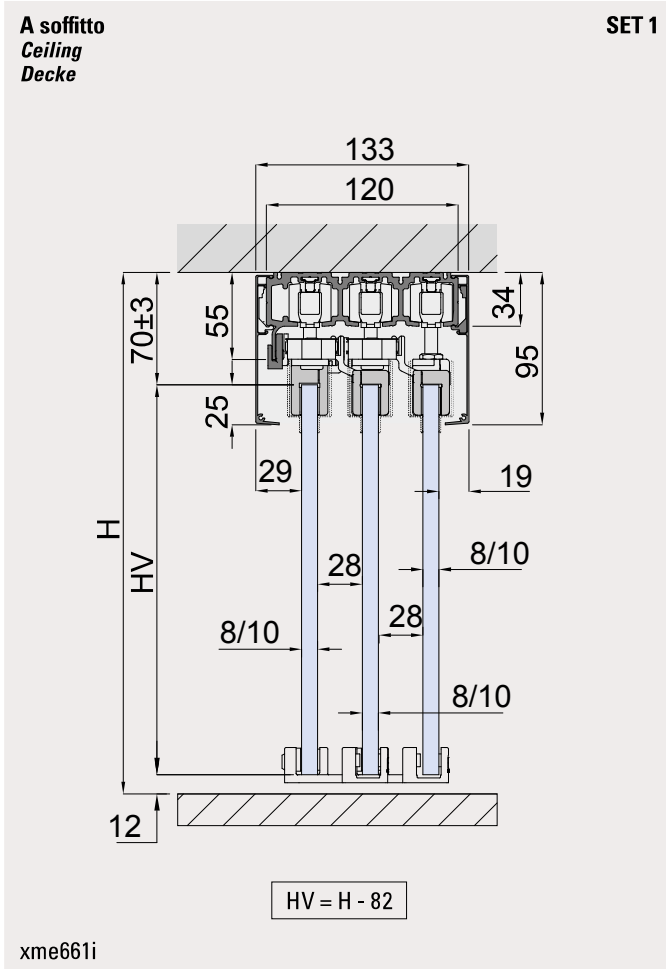

SET 1 / SET 2

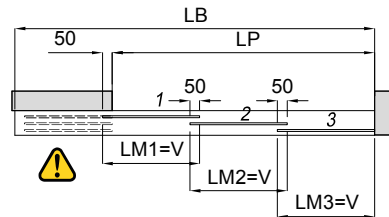
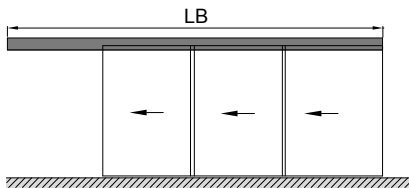

$$V = (LP + 150) / 3$$

$$LB = LP + V + 50 \text{ (MIN)}$$

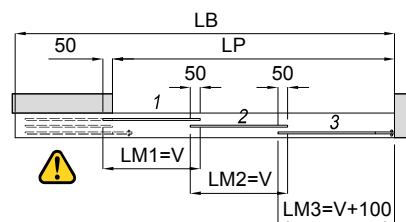
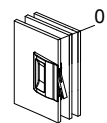

$$V = (LP + 50) / 3$$

$$LB = LP + V + 50 \text{ (MIN)}$$

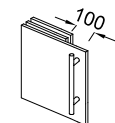

È obbligatorio rispettare la lunghezza del binario come indicato nella formula per allineare i pannelli.
 It is mandatory to calculate the length of the track as in the formula for aligning the panels.
 Zum Ausrichten der Paneele ist unbedingt erforderlich, die in der Formel angegebene Länge der Schiene einzuhalten.



V-1330 SYNCHRO
 TRASCINAMENTO SYNCHRO CON CINGHIA
 SYNCHRO DRAGGING SYSTEM WITH TOOTHED BELT
 SYNCHRO MITNEHMER KIT MIT ZAHNRIEMEN



V-1380 MECH.
 TRASCINAMENTO MECCANICO
 MECHANICAL DRAGGING SYSTEM
 MIT MECHANISHEM MITNEHMER