

## PA-630 FORTI SPESSORI

SCORREVOLI A PARCHEGGIO / SLIDING STACKING SYSTEMS / GANZGLAS-SCHIEBEWANDSYSTEME

- Sistema scorrevole a parcheggio con profili fermavetro su misura richiesta dal cliente, senza fori nel vetro e con possibilità di porta centrale a battente e parcheggiabile.
- Sliding stacking system with glass fixing profiles made to measure upon client's request, no need to make holes in the glass and with the possibility of hinged and parkable center panel.
- Schiebesystem mit Parkraum, mit kundenspezifischen Glasleistenprofile mit zentraler Drehtür und Parkmöglichkeit.

SCORREVOLI A PARCHEGGIO  
SLIDING STACKING SYSTEMS

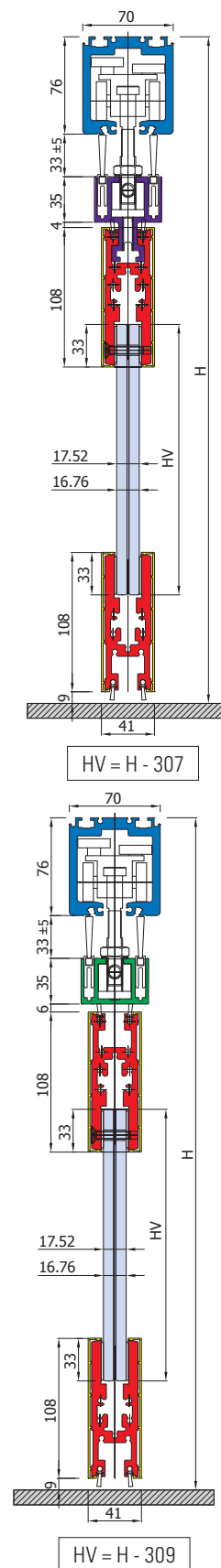

- Porta centrale scorrevole
- Center sliding pivoted door
- Dreh-/pendel Schiebeflügel

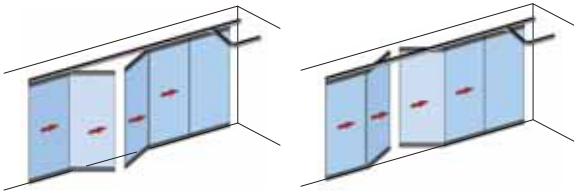

 16,76 17,52	 150 Kg	 110 Kg	 550 min 1000 max
--------------------	------------	------------	-------------------------

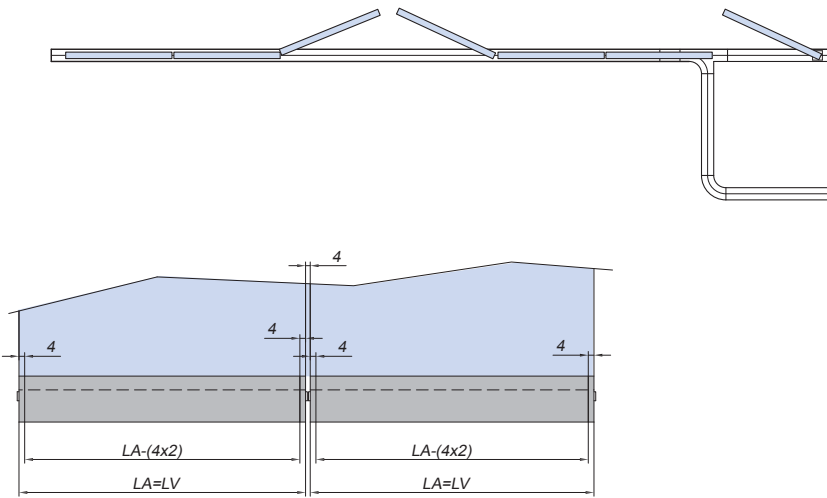

SCORREVOLI A PARCHEGGIO  
SLIDING STACKING SYSTEMS

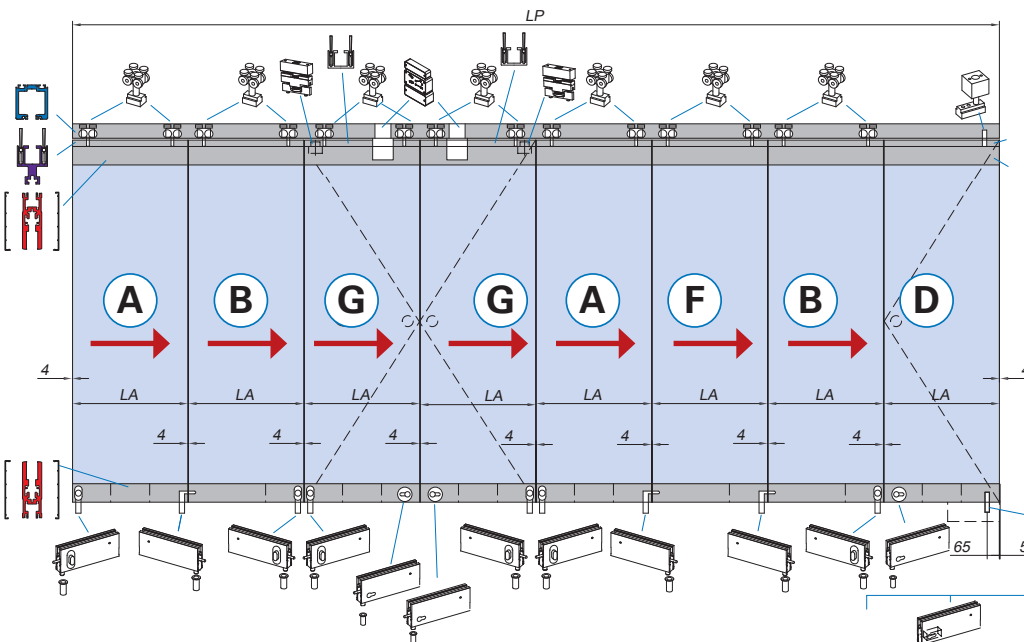

- Calcolo vetro
- Calculation glass
- Glasberechnung

$At = 4 \times (N + 1)$

$X = LP - At$

$LA = LV \times X / N$

- A**
- Prima anta
  - First panel
  - Erster Schiebeflügel

- G**
- Porta centrale scorrevole dx/sx
  - Center sliding pivoted door dx/sx
  - Dreh/Pendel-Schiebeflügel dx/sx

- B**
- Ultima anta
  - Last panel
  - End-Schiebeflügel

- F**
- Anta intermedia
  - Intermediate panel
  - Zwischen-Schiebeflügel

- D**
- Porta laterale
  - Lateral pivot door
  - Dreh-Schiebeflügel

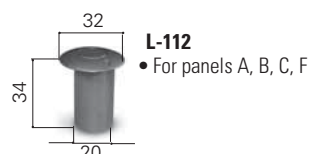
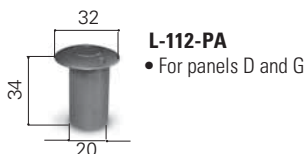

xme527a / xme527f

AN	At	N	LP	LA = LV	H	HV	HA
Alluminio anodizzato Aluminium anodized Aluminium Silberfarbig	Arie totali Total clearances Summe alle Abstände Glas/Wand	Numero ante Numbers panels Anzahl der Elemente	Passaggio luce Clear opening width Lichte Durchgangsbreite	Larghezza ante = Larghezza vetro Panel width = Glass width Flügelbreite = Glasbreite	Altezza passaggio luce Clear opening height Lichte durchgangshöhe	Altezza vetro Glass height Glashöhe	Altezza anta Door height Tür Höhe

**PA-633**

- Scambio per convertire l'anta porta battente del PA-630 in anta scorrevole tramite l'apposita chiave snodata
- Mechanism to convert the center pivoted door of PA-630 in sliding door parkable through the appropriate tool
- System um die zentrale Dreh-Tür des PA-630 in Schiebetür durch das entsprechende Werkzeug umzuwandeln

**PA-308**

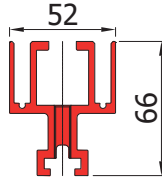

**PA-309**

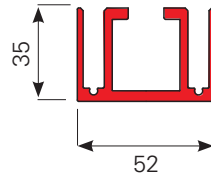

**PA-310**



**PA-311**

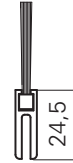

**PA-214**

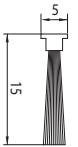

**PA-633**

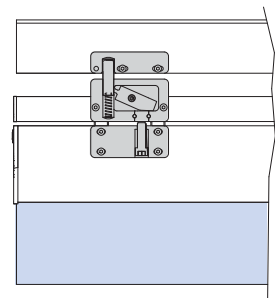
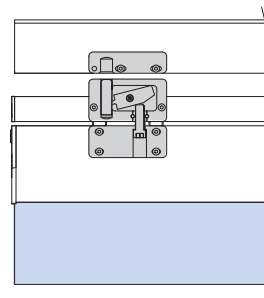
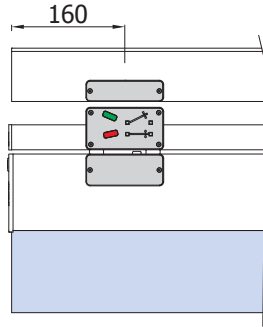
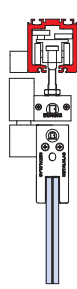
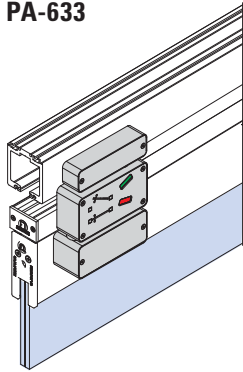

xme527c / xme527e







# PA-630 FORTI SPESSORI

COME USARE **MY METALGLAS** / HOW TO USE **MY METALGLAS** / WIE MAN BENUTZT **MY METALGLAS**

**1** INSERIRE LE MISURE DEL TUO VANO E LE ANTE DESIDERATE  
ENTER THE MEASUREMENTS OF YOUR OPENING AND THE DOORS YOU REQUIRE  
GEBEN SIE DIE MASSE IHRER ÖFFNUNG EIN UND DIE ERFORDERLICHEN TÜREN

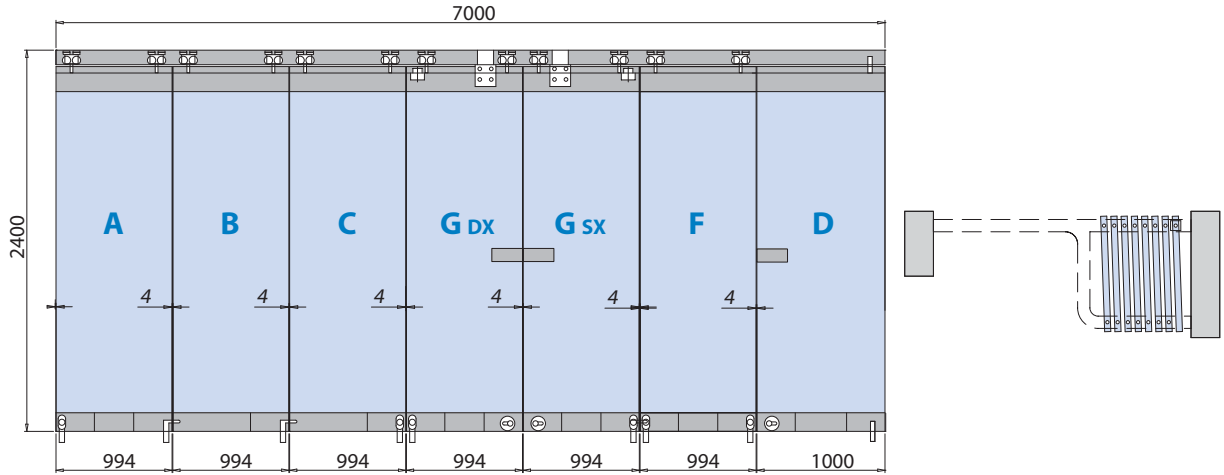

SCORREVOLI A PARCHEGGIO  
SLIDING STACKING SYSTEMS

**2** SI OTTENGONO LE MISURE DEI VETRI AUTOMATICAMENTE  
THE MEASUREMENTS OF THE GLASS WILL BE GENERATED AUTOMATICALLY  
DIE ABMESSUNGEN DES GLASES WERDEN AUTOMATISCH BERECHNET

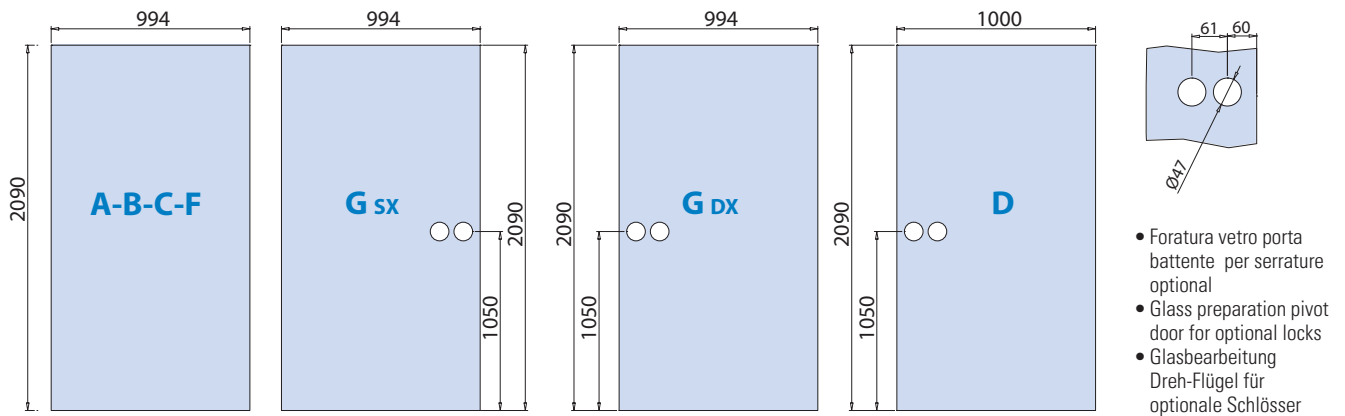

**3** SI OTTENGONO LE DISTINTE DI TAGLIO DEI PROFILI, DA ABBINARE AGLI ACCESSORI  
THE CUTTING SPECIFICATIONS OF THE PROFILES ARE OBTAINED, FOR MATCHING WITH THE ACCESSORIES  
SIE ERHALTEN EINE SPEZIFIKATION DER PROFILLÄNGEN ZUM ABGLEICHEN MIT DEM ZUBEHÖR

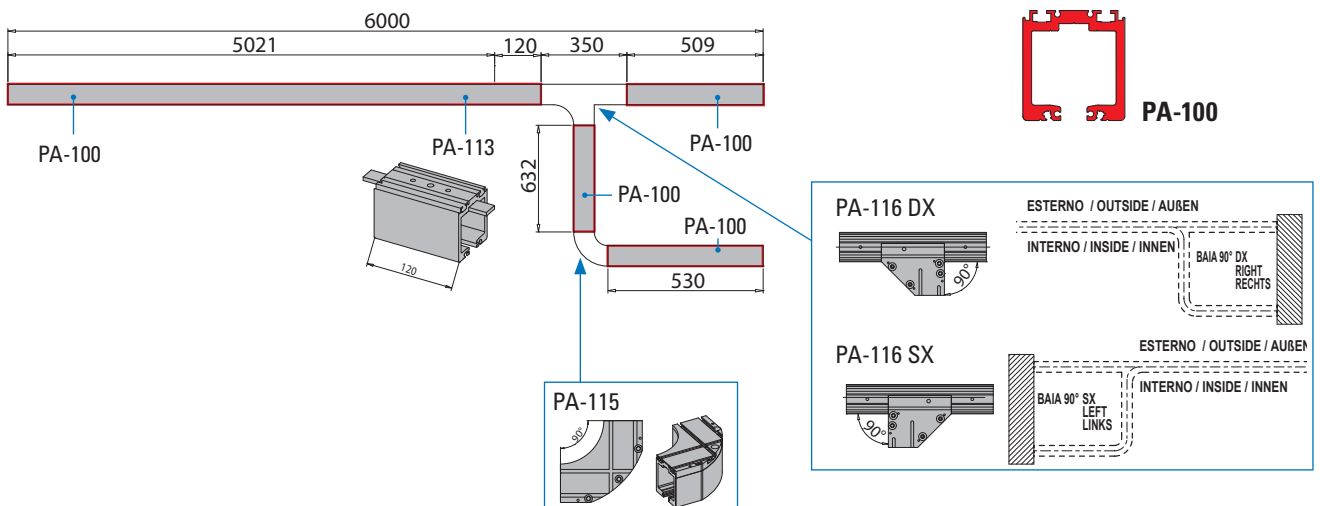

# PA-630 FORTI SPESSORI

## COME ASSEMBLARE LE ANTE / HOW TO ASSEMBLE THE DOORS / WIE DIE TÜREN ZUSAMMENGESSETZT WERDEN

TAGLIO PROFILI  
PROFIL PREPARATION / PROFILBEARBEITUNG

+

KIT ACCESSORI  
ACCESSORY SETS / ZUBEHÖR SETS

=

ANTA COMPLETA  
COMPLETE DOOR / KOMPLETTE TÜR

**ANTA A / DOOR A / TÜRA**

**PA-609 (x 2)** **PA-308 (x 1)** **PA-610 (x 4)** **PA-311 (x 2)**

**SUPERIORE / TOP / OBEN**

**INFERIORE / BOTTOM / UNTEN**

- Lavorazione veletta **PA-610** con **PA-625 + PA-203-POM**
- Cover profile preparation **PA-610** with **PA-625 + PA-203-POM**
- Vorbereitung der Abdeckung **PA-610** mit **PA-625 + PA-203-POM**

**PA-630 ANTA A-16 (for glass 16,76 mm)**  
**PA-630 ANTA A-17 (for glass 17,52 mm)**  
PRIMA ANTA A / ERSTER SCHIEBEFLÜGEL A

 SCORREVOLI A PARCHEGGIO  
SLIDING STACKING SYSTEMS

**ANTA B / DOOR B / TÜRB**

**PA-609 (x 2)** **PA-308 (x 1)** **PA-610 (x 4)** **PA-311 (x 2)**

**SUPERIORE / TOP / OBEN**

**INFERIORE / BOTTOM / UNTEN**

- Lavorazione veletta **PA-610** con **PA-625 + PA-203-POM**
- Cover profile preparation **PA-610** with **PA-625 + PA-203-POM**
- Vorbereitung der Abdeckung **PA-610** mit **PA-625 + PA-203-POM**

**PA-630 ANTA B-16 (for glass 16,76 mm)**  
**PA-630 ANTA B-17 (for glass 17,52 mm)**  
ULTIMA ANTA B / END-SCHIEBEFLÜGEL B

**ANTA F / DOOR F / TÜRF**

**PA-609 (x 2)** **PA-308 (x 1)** **PA-610 (x 4)** **PA-311 (x 2)**

**SUPERIORE / TOP / OBEN**

**INFERIORE / BOTTOM / UNTEN**

**PA-630 ANTA F-16 (for glass 16,76 mm)**  
**PA-630 ANTA F-17 (for glass 17,52 mm)**  
ANTA INTERMEDIA F / ZWISCHEN-SCHIEBEFLÜGEL F

# PA-630 FORTI SPESSORI

COME ASSEMBLARE LE ANTE / HOW TO ASSEMBLE THE DOORS / WIE DIE TÜREN ZUSAMMENSETZT WERDEN

TAGLIO PROFILI  
PROFIL PREPARATION / PROFILBEARBEITUNG



KIT ACCESSORI  
ACCESSORY SETS / ZUBEHÖR SETS



ANTA COMPLETA  
COMPLETE DOOR / KOMPLETTE TÜR

SCORREVOLI A PARCHEGGIO  
SLIDING STACKING SYSTEMS

ANTA G / DOOR G / TÜRG

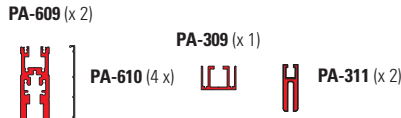

SUPERIORE / TOP / OBEN

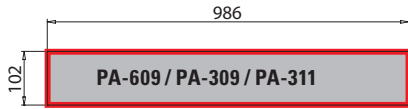

INFERIORE / BOTTOM / UNTEN

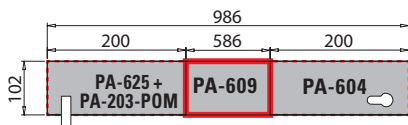

- Lavorazione veletta PA-610 con PA-604 e PA-625 + PA-203-POM
- Cover profile preparation PA-610 with PA-604 and PA-625 + PA-203-POM
- Vorbereitung der Abdeckung PA-610 mit PA-604 und PA-625 + PA-203-POM

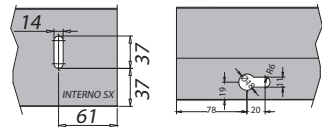

PA-630 ANTA G-16 (for glass 16,76 mm)  
PA-630 ANTA G-17 (for glass 17,52 mm)  
PORTA CENTRALE SCORREVOLE G  
DREH/PENDEL SCHIEBEFLÜGEL G

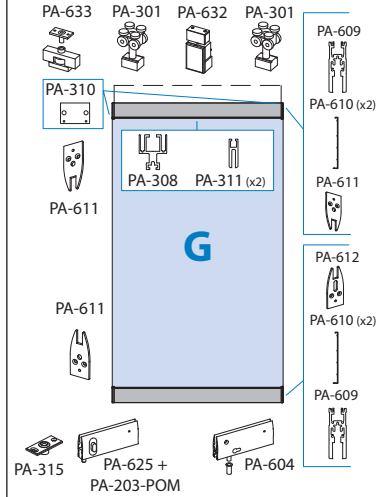

- Lavorazione profili PA-609 / PA-610
- Profiles preparation PA-609 / PA-610
- Vorbereitung der Profile PA-609 / PA-610

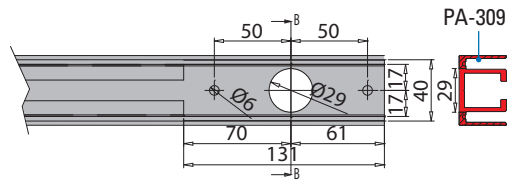
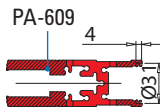
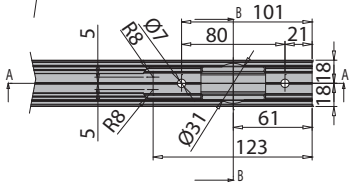
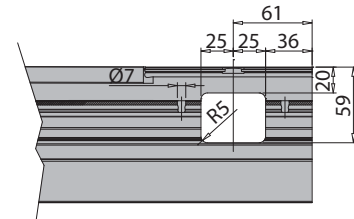

ANTA C / DOOR C / TÜRC

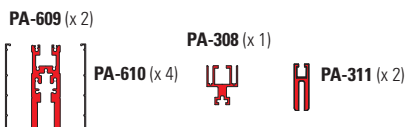

SUPERIORE / TOP / OBEN

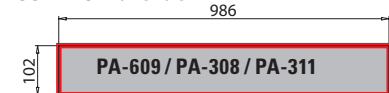

INFERIORE / BOTTOM / UNTEN

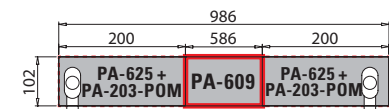

- Lavorazione veletta PA-610 con PA-625 + PA-203-POM
- Cover profile preparation PA-610 with PA-625 + PA-203-POM
- Vorbereitung der Abdeckung PA-610 mit PA-625 + PA-203-POM

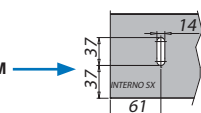

PA-630 ANTA C-16 (for glass 16,76 mm)  
PA-630 ANTA C-17 (for glass 17,52 mm)  
ANTA INTERMEDIA 2 C  
INTERMEDIATE PANEL 2 C  
ZWISCHEN-SCHIEBEFLÜGEL 2 C

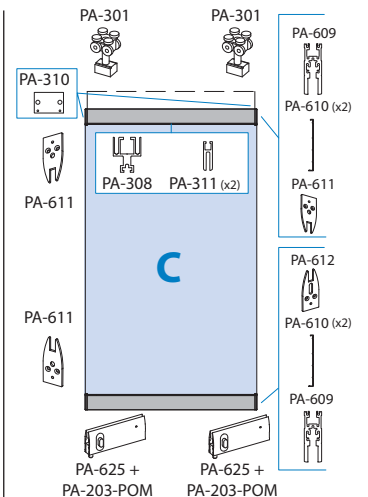
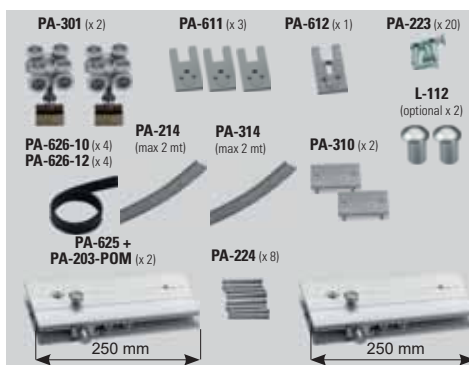



# PA-630 FORTI SPESSORI

## COME ASSEMBLARE LE ANTE / HOW TO ASSEMBLE THE DOORS / WIE DIE TÜREN ZUSAMMENSETZT WERDEN

TAGLIO PROFILI  
PROFIL PREPARATION / PROFILBEARBEITUNG



KIT ACCESSORI  
ACCESSORY SETS / ZUBEHÖR SETS



ANTA COMPLETA  
COMPLETE DOOR / KOMPLETTE TÜR

ANTA D / DOOR D / TÜRD

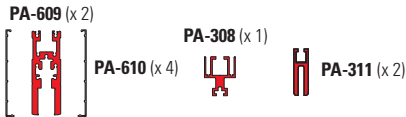

SUPERIORE / TOP / OBEN

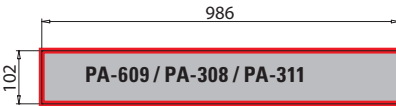

INFERIORE / BOTTOM / UNTEN

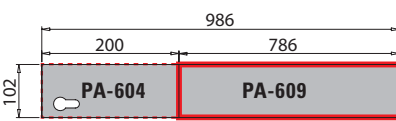

- Lavorazione veletta PA-610 con PA-604
- Cover profile preparation PA-610 with PA-604
- Vorbereitung der Abdeckung PA-610 mit PA-604

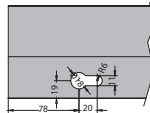

PA-630 ANTA D-16 (for glass 16,76 mm)  
PA-630 ANTA D-17 (for glass 17,52 mm)  
PORTA LATERALE D  
LATERAL PIVOT DOOR D  
DREH-SCHIEBEFLÜGEL D

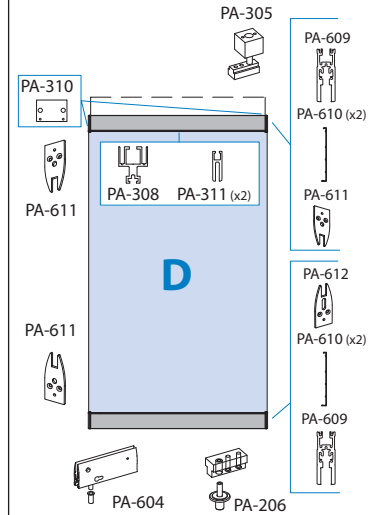

SCORREVOLI A PARCHEGGIO  
SLIDING STACKING SYSTEMS

