

PA-650

SCORREVOLI A LIBRO / SLIDING FOLDING SYSTEMS / FALT-SCHIEBEWANDSYSTEME



- Sistema scorrevole a libro per vetro forti spessori con profili fermavetro continui a misura cliente, completi di catenaccioli ferma anta a posizionamento esterno regolabile.
- Sliding folding door system for thickness 16,76 and 17,52 mm. with glass fixing profiles made to measure upon client's request with an adjustable door holding latch positioned externally.
- Schiebesystem für Glasdicke 16,76 und 17,52 mm. mit durchgehenden kundenspezifischen Glasleistenprofilen, komplett mit äußeren einstellbaren Riegeln zur Flügelfeststellung.

SCORREVOLI A LIBRO
SLIDING FOLDING SYSTEMS

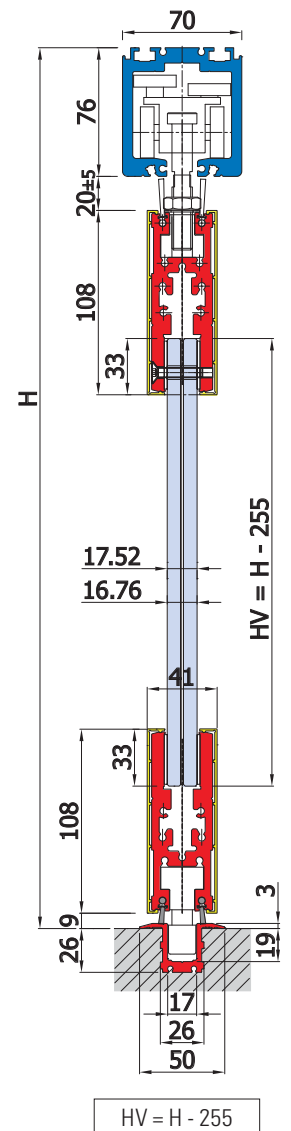

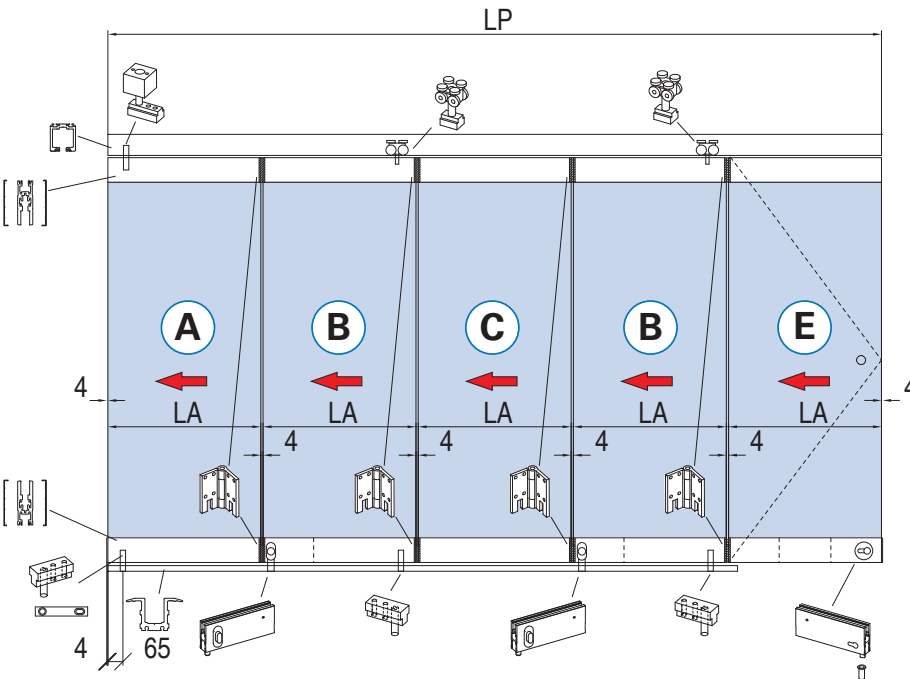
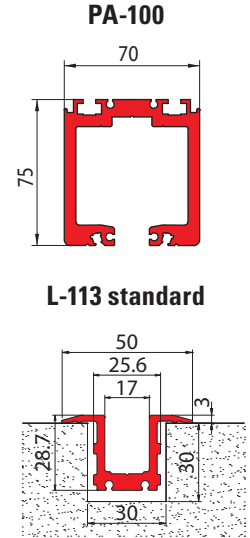
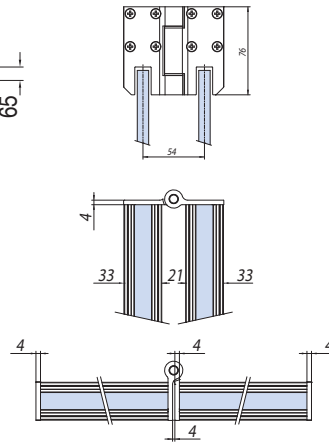
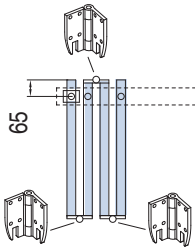
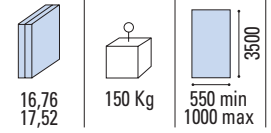
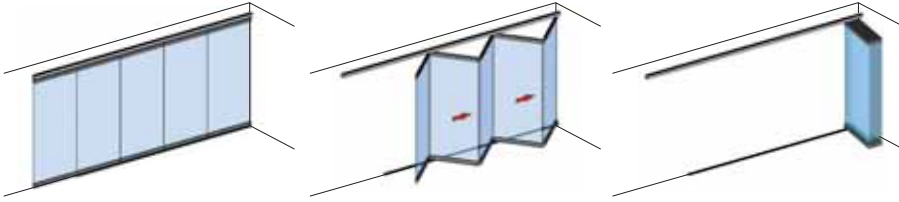

- Calcolo vetro
- Calculation glass
- Glasberechnung

At = 4 x (N + 1)
 X = LP - At
 LA = LV = X / N

	PA-650 SET 2 (A/D)
	PA-650 SET 3 (A/B/E)
	PA-650 SET 4 (A/B/C/D)
	PA-650 SET 5 (A/B/C/B/E)
	PA-650 SET 6 (A/B/C/B/C/D)
	PA-650 SET 7 (A/B/C/B/C/B/E)

- (A)**
 - Prima anta a libro
 - First folding panel
 - Erstes Faltelement
- (B C)**
 - Anta intermedia a libro
 - Intermediate folding panel
 - Mittiges Faltelement
- (D)**
 - Ultima anta porta battente con numero ante pari
 - Last hinged door with even no. panels
 - Letzter Dreh-Flügel bei gerader Flügelanzahl
- (E)**
 - Ultima anta con N° ante dispari
 - Last panel with odd no. panels
 - Letzter Flügel bei ungerader Flügelanzahl



AN	At	N	LP	LA = LV	H	HV	HA
Alluminio anodizzato	Arie totali	Numero ante	Passaggio luce	Larghezza ante = Larghezza vetro	Altezza passaggio luce	Altezza vetro	Altezza anta
Aluminium anodized	Total clearances	Numbers panels	Clear opening width	Panel width = Glass width	Clear opening height	Glass height	Door height
Aluminium Silberfarbig	Summe alle Abstände Glas/Wand	Anzahl der Elemente	Lichte Durchgangsbreite	Flügelbreite = Glasbreite	Lichte durchgangshöhe	Glashöhe	Tür Höhe