

L-1500 LIBRO FOLDING

SCORREVOLI A LIBRO / SLIDING FOLDING SYSTEMS / FALT-SCHIEBEWANDSYSTEME

MY METALGLAS



- Sistema scorrevole a libro con cerniere a vista e fori nel vetro, completo di binario standard h=44 mm x L=64 mm e carrello con 4 ruote.
- Sliding folding door system with visible hinges and holes in glass, including standard rail h=44 mm x L=64 mm and carriage with 4 wheels.
- Faltschiebewandssystem mit sichtbaren Bändern und Glasbohrungen, komplett mit Standard-Laufschiene h=44 mm x L=64 mm und Laufwagen mit 4 Rädern.

SCORREVOLI A LIBRO
SLIDING FOLDING SYSTEMS

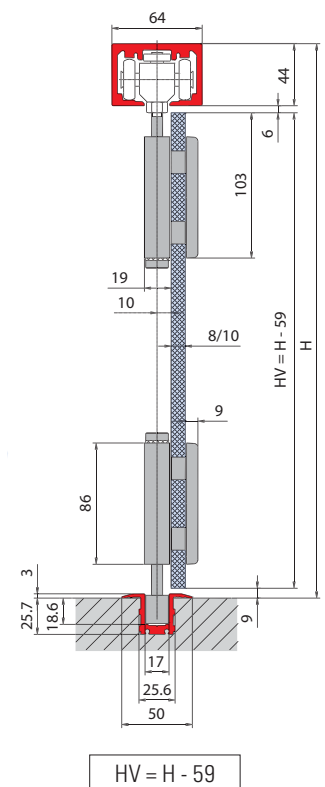

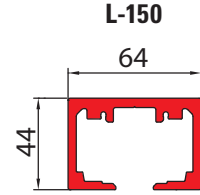
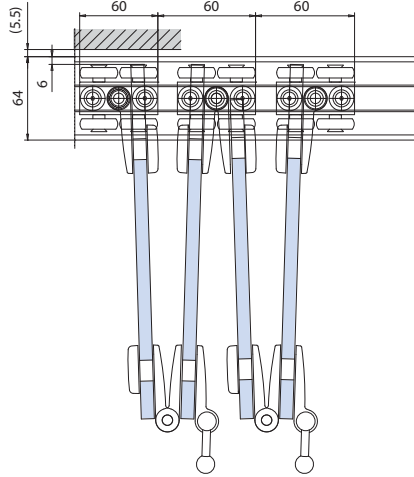
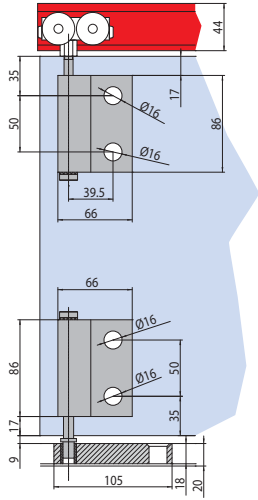
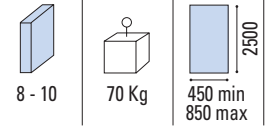
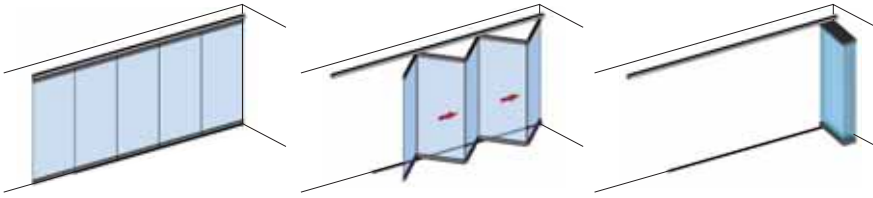

L-113 standard

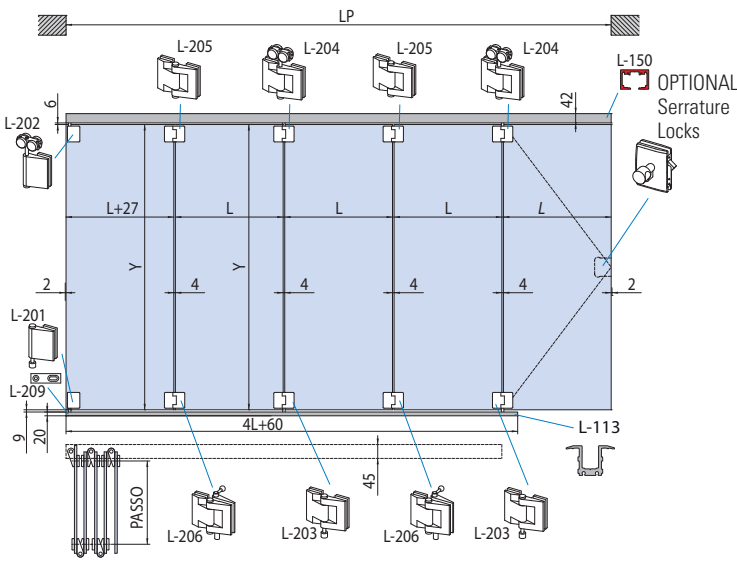
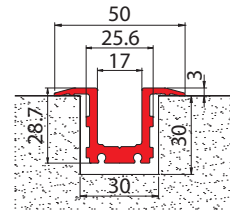

- Calcolo vetro
- Calculation glass
- Glasberechnung

N° ANTE PARI
EVEN NO. PANELS
GERADE FLÜGELANZAHL
 $At = 4 \times N$
 $X = LP - At$
 $L = (X - 54) / N$

N° ANTE DISPARI
ODD NO. PANELS
UNGERADE FLÜGELANZAHL
 $At = 4 \times N$
 $X = LP - At$
 $L = (X - 27) / N$

	L-1500 SET 1	(A)(D)
	L-1500 SET 2	(A)(B)(C)
	L-1500 SET 3	(A)(B)(B)(D)
	L-1500 SET 4	(A)(B)(B)(B)(C)
	L-1500 SET 5	(A)(B)(B)(B)(B)(D)

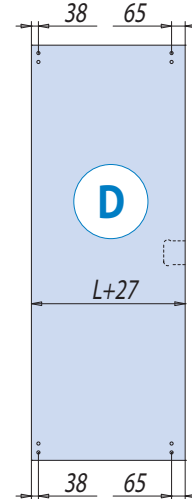
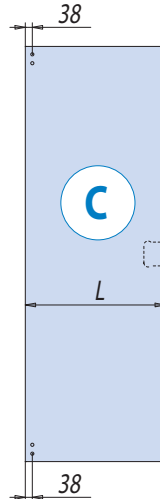
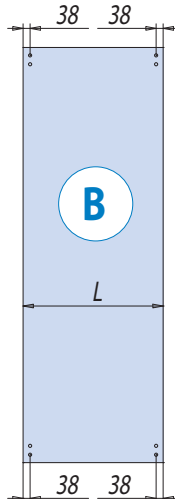
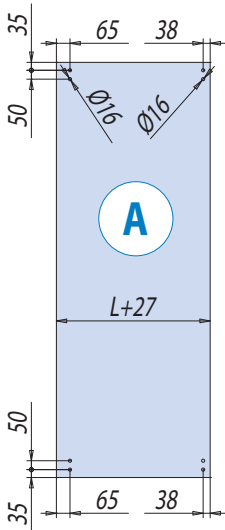

xla178 / xla226

AN Alluminio anodizzato Aluminium anodized Aluminium Silberfarbig	NS Nickel satinato Satin nickel Ähnlich Edelstahl matt	At Arie totali Total clearances Summe alle Abstände Glas/Wand	N Numero ante Numbers panels Anzahl der Elemente	LP Passaggio luce Clear opening width Lichte Durchgangsbreite	LA = LV Larghezza ante = Larghezza vetro Panel width = Glass width Flügelbreite = Glasbreite	H Altezza passaggio luce Clear opening height Lichte durchgangshöhe	HV Altezza vetro Glass height Glashöhe
---	--	---	--	---	--	---	--

L-1500 LIBRO FOLDING / L-2500 (▶ 116) COMPONENTI / COMPONENTS / EINZELTEILE

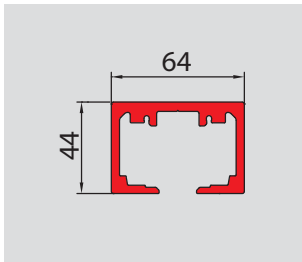

L-150

- Binario superiore di scorrimento in alluminio per sistema L-2500 e L-1500
- Aluminium top track profile for system L-2500 and L-1500
- Aluminium Laufschienenprofil für System L-2500 und L-1500

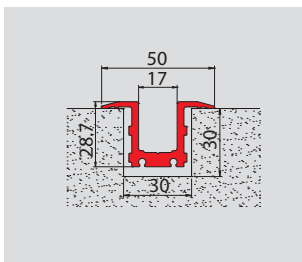

L-113

- Canalina a terra in alluminio (standard già inclusa nel set)
- Floor channel, floor installation (standard included in folding set)
- Bodenführung mit Bodenvorbereitung (Standard im Set enthalten)

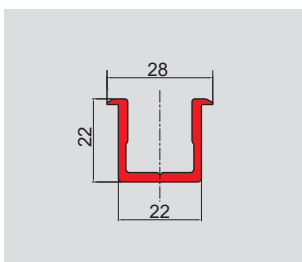

L-110

- Guida a pavimento
- Bottom rail
- Bodenführung

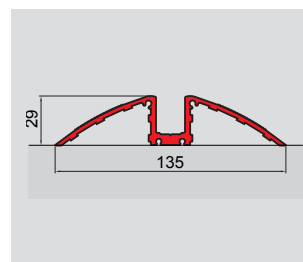

L-115

- Guida a pavimento
- Bottom rail
- Bodenführung



L-201

- Cerniera laterale inferiore per prima/ultima anta
- Bottom hinge fitting for first/last panel
- Unteres seitliches Band für erstes/letztes Element



L-202

- Cerniera laterale superiore per prima/ultima anta
- Top hinge fitting for first/last panel
- Oberes seitliches Band für erstes/letztes Element



L-203

- Cerniera inferiore di scorrimento per guida pavimento
- Bottom sliding hinge for bottom rail
- Unteres Faltband für Fußboden Führung

L-1500 LIBRO FOLDING

SCORREVOLI A LIBRO / SLIDING FOLDING SYSTEMS / FALT-SCHIEBEWANDSYSTEME

MY METALGLAS



- Sistema scorrevole a libro con cerniere a vista e fori nel vetro, completo di binario standard h=44 mm x L=64 mm e carrello con 4 ruote.
- Sliding folding door system with visible hinges and holes in glass, including standard rail h=44 mm x L=64 mm and carriage with 4 wheels.
- Faltschiebewandssystem mit sichtbaren Bändern und Glasbohrungen, komplett mit Standard-Laufschiene h=44 mm x L=64 mm und Laufwagen mit 4 Rädern.

SCORREVOLI A LIBRO
SLIDING FOLDING SYSTEMS

