

# POMOLI

## KNOBS / KNÖPFE



### V-024 25

- Coppia pomoli Ø 25 mm.
- Pair of doorknobs Ø 25 mm.
- Paar Türknöpfe Ø 25 mm.

CR - NS

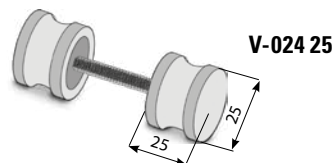

eP F.108 eP F.109  
eP F.110 eP F.111

### V-024 30

- Coppia pomoli Ø 30 mm.
- Pair of doorknobs Ø 30 mm.
- Paar Türknöpfe Ø 30 mm.

CR - NS

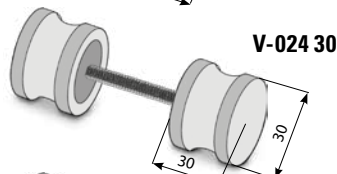

### V-024 32

- Coppia pomoli Ø 32 mm.
- Pair of doorknobs Ø 32 mm.
- Paar Türknöpfe Ø 32 mm.

CR - NS

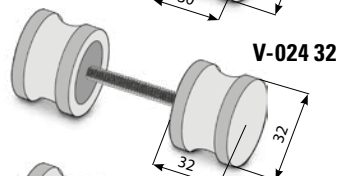

### V-024 38

- Coppia pomoli Ø 38 mm.
- Pair of doorknobs Ø 38 mm.
- Paar Türknöpfe Ø 38 mm.

CR - NS

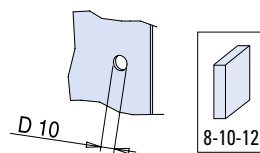
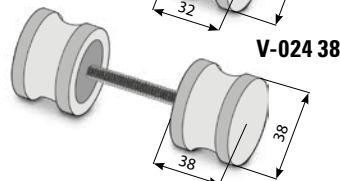

### V-1107

- Coppia pomoli 35 x 35 mm foro vetro Ø 10 mm
- Pair of doorknobs 35 x 35 mm. Hole in glass 10 mm
- Paar Türknöpfe 35 x 35 mm. Glas Bohrung 10 mm

CR

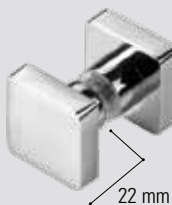

eP F.118

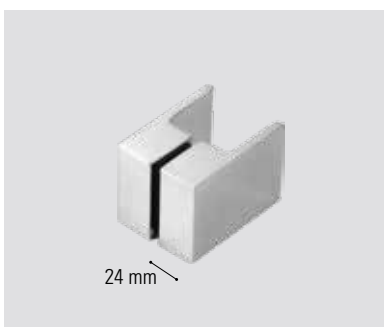
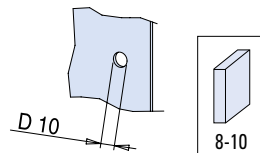

### B-197

- Coppia pomoli 70 x 50 mm
- Pair of doorknobs 70 x 50 mm
- Paar Türknöpfe 70 x 50 mm

CR

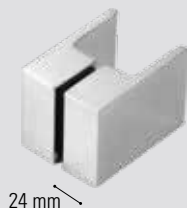

eP F.127

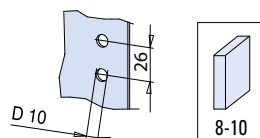

### B-168

- Pomolo per porte in Zama.
- Glass doors knob Zamak.
- Paar Türknöpfe aus Zamak.

CR - NS - CP - NO

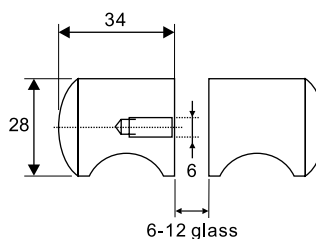

eP F.112

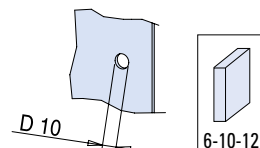



**B-169**

- Coppia pomoli 28 x 28 mm.
- Pair of doorknobs 28 x 28 mm.
- Paar Türknöpfe 28 x 28 mm.

CR

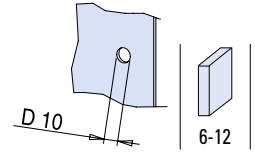
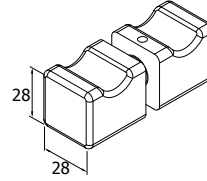
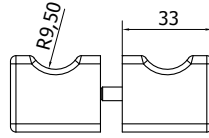

eP F.113



**B-177**

- Paio pomolini tondi d. 15
- Pair mini knobs d. 15
- Pair mini knobs d. 15

IL - IX

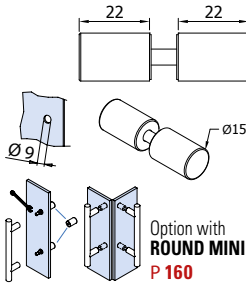

**B-178**

- Paio pomolini quadri q. 15
- Pair mini knobs q. 15
- Paar Knöpfe mini q.15

IL - IX

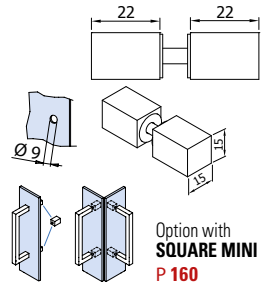

eP F.115



**POR-153V**

- Paio pomoli Ø 25 - H 32
- Pair knobs Ø 25 - H 32
- Paar Knöpfe Ø 25 - H 32

NS - CR

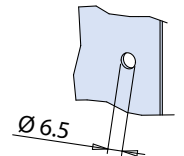
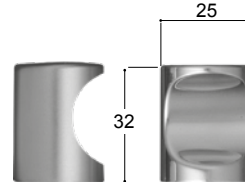

eP F.119



**B-194**

- Coppia pomoli Ø 32 mm - Foro vetro Ø 10 mm
- Pair of doorknobs Ø 32 mm - Hole in glass 10 mm
- Paar Türknöpfe Ø 32 mm Glas Bohrung 10 mm

CR - NS

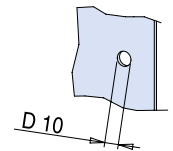

eP F.116



**B-195**

- Coppia pomoli 25x25 mm - Foro vetro Ø 10 mm
- Pair of doorknobs 25x25 mm - Hole in glass 10 mm
- Paar Türknöpfe 25x25 mm Glas Bohrung 10 mm

CR - NS

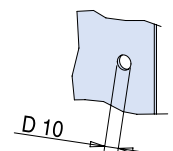

eP F.117

**NS**  
Nickel satinato  
Satin nickel  
Ähnlich Edelstahl matt

**CR**  
Cromo lucido  
Polished chrome  
Chrom glänzend

**CS**  
Cromo satinato  
Satin chrome  
Chrom matt

**OL**  
Ottone lucido  
Polished brass  
Messing poliert

**CP**  
Cromo perla  
Chrome perla similar Alu  
Chrom perla ähnlich Alu

**AN**  
Alluminio anodizzato  
Aluminium anodized  
Aluminium Silberfarbig

**NO**  
Nero opaco  
Matt black  
Schwarz matt



**V-013**

- Coppia pomoli palla Ø 50 mm.
- Pair of door knobs Ø 50 mm.
- Paar Türknöpfe Ø 50 mm.

CS - NS - CR - OL

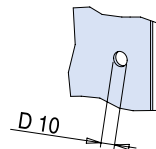
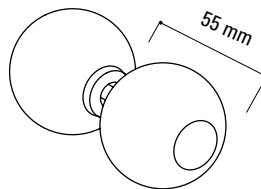

eP F.104



**V-019**

- Coppia pomoli in vetro.
- Pair of door knobs in glass.
- Paar Türknöpfe aus Glas.

NS + GLASS

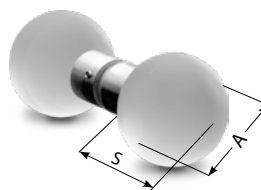

A = 40 / 45 / 50  
S = 52 / 57 / 62

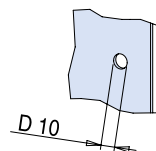

eP F.107

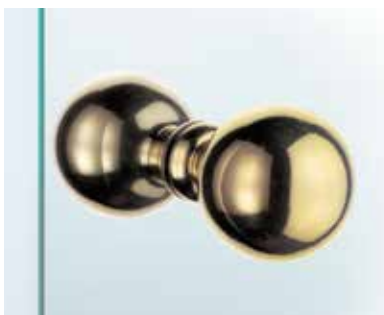

**V-1056**

- Coppia pomoli palla Ø 60 mm.
- Pair of door knobs Ø 60 mm.
- Paar Türknöpfe Ø 60 mm.

**V-1056-2**

- Coppia pomoli palla Ø 50 mm.
- Pair of door knobs Ø 50 mm.
- Paar Türknöpfe Ø 50 mm.

CS - NS - CR - OL - CP

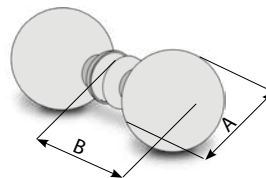

Ø 60 A = 60 / B = 78  
Ø 50 A = 50 / B = 70

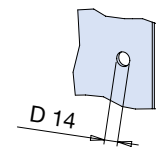

eP F.100 eP F.101



**V-1056-WE**

- Pomolo fisso ø 60 con rosetta filettata per montaggio su serrature "Metalglas" in abbinamento a mezza maniglia (non inclusa). Non disponibile per V-900 e V-920
- Fixed knob ø 60 on threaded rosette for installation with "Metalglas" locks and turnable half handle (not included). Not available for lock V-900
- Festehender Knopf ø 60 auf Wechselstift mit Gewinderosette montierbar mit "Metalglas" Schlösser. Nicht verfügbar für V-900

CS - NS - CR - OL - CP

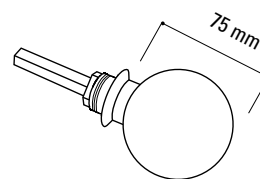

eP F.103



**V-1105**

- Coppia pomoli piatti Ø 55 mm.
- Pair of doorknobs Ø 55 mm.
- Paar Türknöpfe Ø 55 mm.

CS - NS - CR - OL - CP

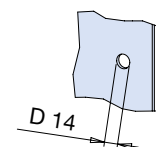
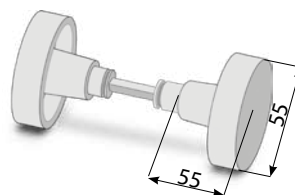

eP F.105



**V-1105-WE**

- Pomolo fisso Ø 55 mm con rosetta filettata per montaggio su serrature "Metalglas" in abbinamento a mezza maniglia (non inclusa)
- Fixed knob Ø 55 mm on threaded rosette for installation with "Metalglas" locks and turnable half handle (not included)
- Festehender Knopf Ø 55 mm auf Wechselstift mit Gewinderosette montierbar mit "Metalglas" Schlösser

CS - NS - CR - OL - CP

- **Non disponibile per V-900 e V-920**
- Not available for V-900 and V-920
- Nicht verfügbar für V-900 und V-920

eP F.106

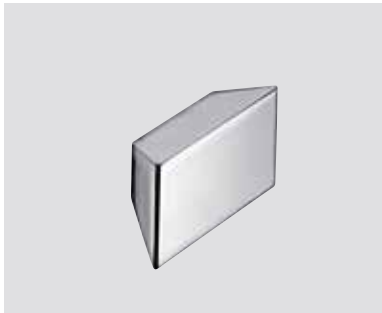
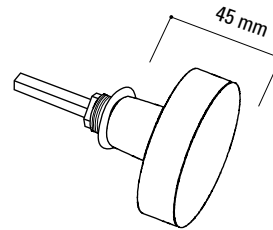

**B-193**

- Maniglietta ad incollaggio biadesivo.
- Small handle with self-adhesive fixing.
- Kleine griffe selbstklebend.

CR

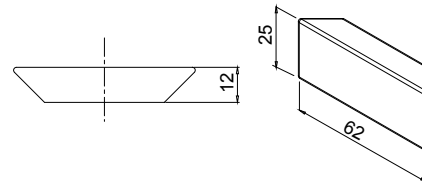

eP F.193

xme311



**B-192**

- Pomolo ad incollaggio biadesivo.
- Knob with self-adhesive fixing.
- Knopf selbstklebend.

CR

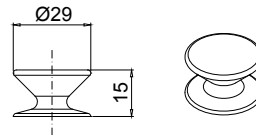

eP F.125

xme311

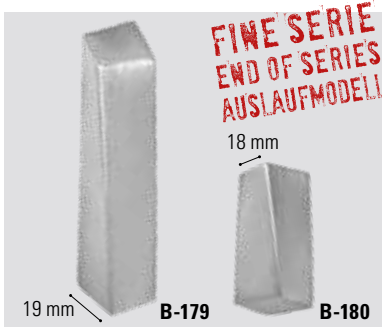

**B-179**

- Maniglietta ad incollaggio biadesivo, versione lunga
- Small handle with selfadhesive fixing
- Kleine griffe selbstklebend

**B-180**

- Maniglietta ad incollaggio biadesivo, versione corta
- Small handle with selfadhesive fixing
- Kleine griffe selbstklebend

CS - CR

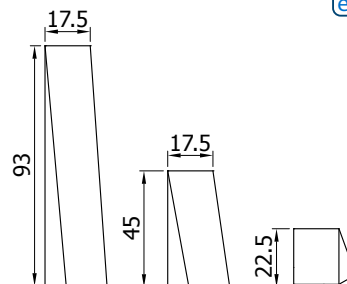

eP F.121

eP F.122



**B-191-80 / B-191-240**

- Maniglietta ad incollaggio biadesivo.
- Small handle with self-adhesive fixing.
- Kleine griffe selbstklebend.

CR



		B-191-80	B-191-240
TL	80	•	
	240		•

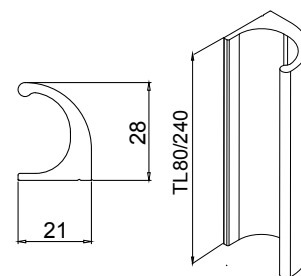

eP F.124

xme311

**NS**  
Nickel satinato  
Satin nickel  
Ähnlich Edelstahl matt

**CR**  
Cromo lucido  
Polished chrome  
Chrom glänzend

**CS**  
Cromo satinato  
Satin chrome  
Chrom matt

**OL**  
Ottone lucido  
Polished brass  
Messing poliert

**CP**  
Cromo perla  
Chrome perla similar Alu  
Chrom perla ähnlich Alu

**AN**  
Alluminio anodizzato  
Aluminium anodized  
Aluminium Silberfarbig

**NO**  
Nero opaco  
Matt black  
Schwarz matt